

# Architectural Door Accessories

**ASSA ABLOY**

Experience a safer  
and more open world

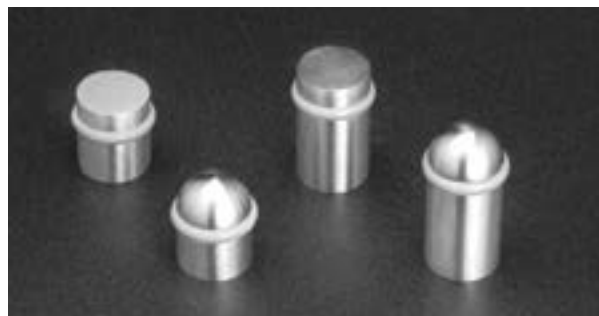
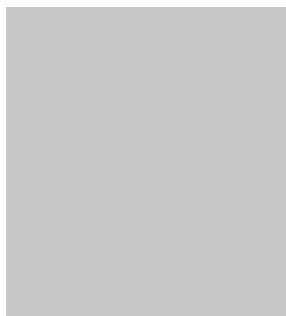

## Rockwood Products Price Book - Architectural Series

USA & Canada Prices Effective March 16, 2020

## Table of Contents

<b>General Information</b>	<b>2-5</b>	PlanTek (flat front pulls)	42
Numeric Index	3	RightAngles (w/ or w/o GripZone)	7
Ordering Information	4	SkewTek (angled end pulls)	39
Post Mounted Pulls/General Information	5	SoftMet (*Santoprene™ grip)	18
<b>Architectural Pulls</b>	<b>6-55</b>	SoftTek (Santoprene™ grip)	18
AccenTek™ (solid pulls with accents)	41	Traditional (decorative pulls & plates)	43
AccenTek™ Solid Groove Pulls	41	Tubular (1 ¼" and 1 ½" diameter pulls)	6
ArborMet (wood grip pulls)	33-35	<b>Leather Architectural Pulls</b>	<b>44-52</b>
ArborTek (wood grip pulls)	36-39	English Bridle Leather (straight & offset pulls)	44-52
BandWidth (collar mount pulls)	14	Flush Leather Pulls	49-51
CenTrex (shaped pulls)	40	Leather Oval (ergonomic pulls)	48
Classic (finial pulls)	43	Upholstery Leather GeoMetek	52
Edge Pulls (for closet doors)	8	Upholstery Leather (straight & offset pulls)	46-47
Flush Pulls	7	<b>Small Architectural Pulls</b>	<b>7-53</b>
GeoMetek (hex, diamond & narrow profile pulls)	55-56	ArborMet	12
Groove (straight & offset pulls)	19	GripZone	11
LineaMax (grooved pulls)	25-28	Groove	11
Locking Door Pull System	56-59	Leather	53
MariTek (tapered pulls)	43	MegaTek	10
MegaCurve (long curved pulls)	12	NoirMet	12
MegaTek (straight & offset pulls)	20-22	Wire	7
MezzoTek (necked post pulls)	13	<b>Architectural Accessories</b>	<b>8-9</b>
NeoCylinder (w/ or w/o GripZone)	54	Coat Hooks	8
NeoMax (pulls w/GripZone)	23-25	Door Stops	9
NeoMetrix (w/GripZone)	19	Push Plates, Pull Plates and Signage	9
NeoMitre (w/ or w/o GripZone)	54	<b>Architectural Finishes</b>	<b>61</b>
NoirMet (black anodized grip)	29-30	<b>Mounting Types</b>	<b>62</b>
NoirTek (black anodized grip)	31-32	<b>Mounting Details</b>	<b>63-64</b>
OvalTek (true oval grip)	16	<b>Fasteners - Spare Parts</b>	<b>65-67</b>
OvalTek (flat oval grip)	17	<b>Mounting Kits</b>	<b>68</b>
Storefront Panic Device	60	<b>Discontinued Products</b>	<b>69-70</b>

\*Santoprene™ is a registered trademark of the Exxon Mobil Corporation.

# ASSA ABLOY

Experience a safer  
and more open world

USA & Canada Prices Effective March 16, 2020

Copyright © 2020, ASSA ABLOY Accessories and Door Controls Group, Inc. All rights reserved. Reproduction in whole or in part without the express written permission of ASSA ABLOY Accessories and Door Controls Group, Inc. is prohibited.

**Numeric Index**

No.	Description	Page
570	Dust Proof Strike.....	59
DP3301	MegaTek Dummy Pull (round).....	59
DP3401	NeoTek Dummy Pull.....	59
DP7901	GeoMetek Dummy Pull (square)....	59
LP3301	Locking Pull PostMount.....	57
LP3305	Locking Pull PostMount.....	57
LP3401	Locking Pull NeoTek.....	57
LP6061	Locking Pull English Bridle ..... Leather Wrapped	58
LP6161	Locking Pull Upholstery..... Leather Wrapped	58
LP6440	Locking Pull Upholstery..... Leather Wrapped	59
LP7901	Locking Pull GeoMetek.....	59
LPS01 - LPS06	Locking Pull Strikes.....	59
PDU8500 - PDU8500-6	Storefront Panic Device.....	60
RM201 - RM372	Tubular.....	6
RM405 - RM423	RightAngles.....	7
RM710 - RM735	Small Pulls (Wire).....	7
RM751 - RM760	Edge Pulls - for Closet Doors.....	8
RM780 - RM790	Flush Pulls.....	7
RM801 - RM843	Coat Hooks.....	8
RM850 - RM877	Door Stops.....	9
RM1010 - RM1160	Push Plates, Pull Plates, ..... and Signage	9
RM1200 - RM1270	Small Pulls (MegaTek, Groove)..	10-11
RM1300 - RM1370	Small Pulls (GripZone).....	11
RM1410 - RM1470	Small Pulls (NoirMet).....	12
RM1510 - RM1570	Small Pulls (ArborMet).....	12
RM2000 - RM2034	MegaCurve.....	12
RM2110 - RM2150	MezzoTek.....	13
RM2200 - RM2244	BandWidth.....	15
RM2300 - RM2330	OvalTek (true oval).....	16
RM2400 - RM2420	OvalTek (flat oval).....	17

No.	Description	Page
RM2510 - RM2544	SoftMet.....	18
RM2610 - RM2640	SoftTek.....	18
RM3010 - RM3060	NeoMetrix.....	19
RM3100 - RM3154	See RM3300-RM3342	
RM3101 - RM3131	Groove.....	19
RM3300 - RM3342	MegaTek.....	20-22
RM3400 - RM3442	NeoMax.....	23-25
RM3512 - RM3782	LineaMax.....	25-28
RM3800 - RM3854	NoirMet.....	29-30
RM3900 - RM3954	NoirTek.....	31-32
RM4000 - RM4054	ArborMet.....	33-35
RM4100 - RM4190	ArborTek.....	36-39
RM4200 - RM4274	SkewTek.....	39
RM4400 - RM4516RH	Centrex.....	40
RM4700 - RM4820	AccenTek™.....	41
RM5200 - RM5280	PlanTek.....	42
RM5500 - RM5598	Traditional.....	43
RM5650 - RM5670	Classic.....	43
RM5700 - RM5702	MariTek.....	43
RM6060 - RM6092	English Bridle Leather.....	44-45
RM6160 - RM6192	Upholstery Leather.....	46-47
RM6200 - RM6240	Leather Oval.....	48
RM6300 - RM6354	Flush Leather Pulls.....	49-51
RM6400 - RM6440	Upholstery Leather GeoMetek.....	52
RM6500 - RM6730	Small Pulls (Leather).....	53
RM7210 - RM7240	NeoCylinder.....	54
RM7300 - RM7450	NeoMitre.....	54
RM7700 - RM7815	GeoMetek (Hexagonal).....	55
RM7800 - RM7815	GeoMetek (Diamond).....	55
RM7900 - RM7960	GeoMetek (Narrow Profile).....	55-56
SP1001 - SP1082	Fasteners - Spare Parts.....	63-67
KIT1 - KITRM380G	Mounting Kits.....	68

## Ordering Information

This price list cancels and supersedes all prior listings.

Orders are accepted with the understanding that they will be billed at prices in effect at time of shipment.

Prices are subject to change without notice.

We reserve the right to decline the whole or part of orders in which the price or quantity of goods is not acceptable to us.

NOTE: If matching pulls to a previous job, please provide original PO or Order #.

## Easy Order Placement

### USA:

By Phone: 1-800-458-2424 Monday through Thursday 8:00 am ET to 7:30 pm ET, Friday 8:00 am ET to 4:30 pm ET

By Fax: Orders may be faxed to 1-800-922-9212

By Email: [orders.rockwood@assaabloy.com](mailto:orders.rockwood@assaabloy.com)

By Internet: <http://extranet.assaabloydss.com/> and select Order Entry under the Customer Service Menu

### Canada:

By Phone: 1-800-461-3007 Monday through Friday 8:00 am ET to 4:30 pm ET

By Fax: Orders may be faxed to 1-800-461-8989

By Email: [cavau-orders@assaabloy.com](mailto:cavau-orders@assaabloy.com)

By Internet: <http://extranet.assaabloydss.ca/> and select Order Entry under the Customer Service Menu

## Terms and Conditions of Sale

Terms: 1% 15 days, net 30 days

Remit Payment To: PNC Bank/Rockwood, PO Box 644489, Pittsburgh, PA 15264-4489

For Terms & Conditions and Warranty information pertaining to product sales in Canada, please visit [www.assaabloy.ca/terms](http://www.assaabloy.ca/terms)

## Freight Policy

Freight Allowance: All prices are F.O.B. Rockwood, Pennsylvania and/or Ventura, California. Full freight will be allowed on shipments of \$1,000 net and over within the continental limits of the United States (excluding Alaska and Hawaii). All shipments are routed most cost effective route of our choice. We reserve the right to designate the carrier.

## Special Order Material

Special items made to your specifications are not returnable. These items are not subject to cancellation without consideration of expense involved at the cancellation date.

## Samples

Salable samples will be charged at regular prices.

## Returned Goods

Return no merchandise without written permission from the factory. Authorization will insure your receiving proper credit. Errors in shipping may occasionally occur. If this is the case immediately notify the factory, and we will gladly make the proper adjustments. If the error is at the customer's end, a minimum charge of 25% plus freight will be incurred for handling. Unauthorized claims for labor or charges will not be allowed. No credit will be allowed beyond six months after invoice date.

## Shortages

Claims for shortages must be made within 30 days of invoice date.

## Templates

Upon request we will furnish templates for any of our standard items of manufacture. Commonly used templates are available on our website at [www.assaabloydooraccessories.us](http://www.assaabloydooraccessories.us).

## Product Weight Information

NOTE: Weights indicated throughout the price list are approximate for brass, bronze or stainless steel base material. Aluminum base materials weigh approximately  $\frac{1}{3}$  the listed weights.

## Engraving

Engraving may be added on many pulls and plates. Call factory for pricing.

**For Terms and Conditions as well as Warranty information pertaining to product sales in Canada, please visit [www.assaabloy.ca/terms](http://www.assaabloy.ca/terms)**

# ASSA ABLOY

Experience a safer  
and more open world

## Post Mounted Pulls

It is our goal that you get the best possible functional and aesthetic door pull from our wide selection. On long door pulls there will naturally be a small amount of flexing between mounting points that are far apart. We offer the following guidelines to help you determine when a mid-post is required or when you should consider altering the location of the mounting posts (by moving them closer together) in order to minimize the flexing of the grip. Making the grip rigid by adding a mid-post is the ideal condition for long pulls on all doors but is particularly important on all glass doors that have an inherent flexing in the door itself. The combined flexing of the door and the pull can loosen mechanical joints and stress the fasteners.

Our recommendations for adding a mid-post to long door pulls is based on a theoretical pull load of 30 lbs. (foot pounds) maximum to open the door, which is a greater than the typical force required to open an average door. The maximum amount of deflection of the grip you will see at that force is  $\frac{3}{8}$ ". The conditions on your job site can vary due to door weight, wind loading, closer settings, locked doors being aggressively pulled and other circumstances. It is our recommendation that you add a mid-post if there is any question about heavy or hard to open doors; having an extra mounting point always makes for a more stable and durable installation.

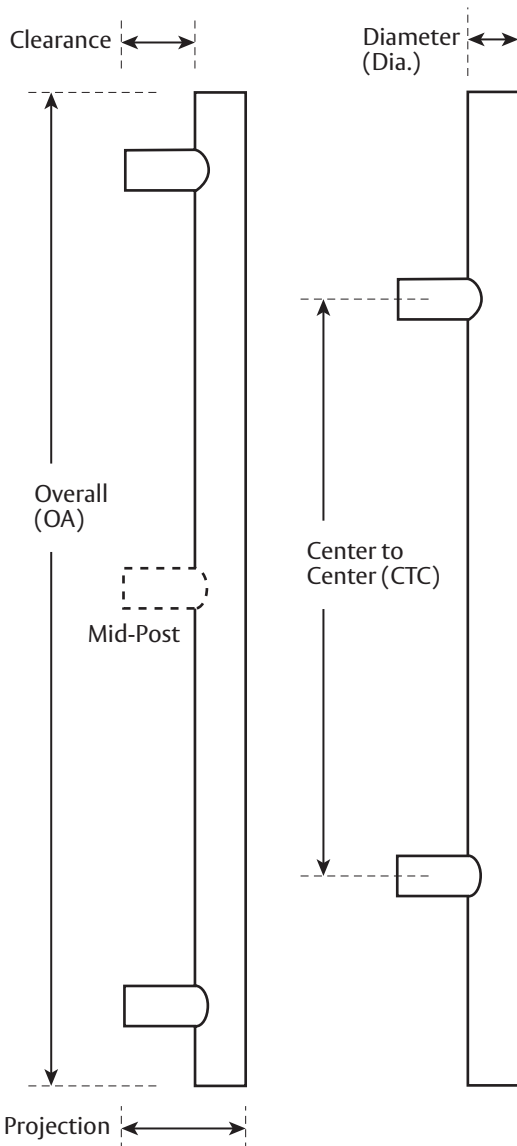

On long pulls, post can be positioned closer to each other and farther away from ends as a strategy to avoid mid-post if door condition permits.

POST MOUNTED PULLS SHAPES AND SIZES			
SHAPE	MATERIAL	MATERIAL Size	MAXIMUM CTC
<b>Round</b>			
	Stainless Steel	1"	70"
		1 1/4"	90"
		1 1/2"	110"
	Brass/Bronze	1"	57"
		1 1/4"	73"
		1 1/2"	87"
Aluminum	1"	66"*	
	1 1/4"	90"*	
	1 1/2"	115"*	
<b>Oval</b>			
	Stainless Steel	1" x 1 1/2"	100"
		1" x 1 7/8"	119"
<b>Flat Oval</b>			
	Stainless Steel	3/4" x 1 1/2"	93"
<b>Square</b>			
	Stainless Steel	3/4" x 3/4"	62"
		1" x 1"	85"
<b>Rectangular</b>			
	Stainless Steel	1/2" x 1 1/4"	86"
		3/4" x 1 1/2"	110"
	Brass/Bronze	3/4" x 1 1/2"	89"
<b>Rectangular</b>			
	Stainless Steel	1/2" x 1 1/4"	52"
		3/4" x 1 1/2"	75"
	Brass/Bronze	3/4" x 1 1/2"	60"

\*The maximum length of anodized aluminum pulls is 87" due to our tank size. Longer aluminum pulls are available in satin finish and clear coated or powder coat paint.

\*The maximum length to powder coat a pull is 118".

**ASSA ABLOY**

Experience a safer  
and more open world

Tubular - 1 1/4" & 1 1/2" Diameter Pulls

Straight Pulls											
Part	CTC	Dia.	28/628	313/710 315/711	3/605 4/606	10/612 10B/613	Stock PC 10BE	32D/630	32/629	32D316	32316
RM301	12"	1 1/4"	147	162	370	400	208	140	158	200	224
RM302	18"	1 1/4"	164	182	393	424	230	162	182	230	257
RM303	24"	1 1/4"	182	200	414	447	252	183	205	260	291
RM304	36"	1 1/4"	217	240	459	497	332	225	252	319	356
RM321	12"	1 1/2"	164	181	449	485	245	176	197	249	278
RM322	18"	1 1/2"	182	200	472	510	267	197	220	279	311
RM323	24"	1 1/2"	199	219	494	534	288	217	243	308	345
RM324	36"	1 1/2"	234	259	538	581	369	259	290	368	412

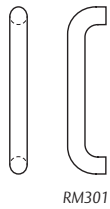

RM301

90° Offset Pulls											
Part	CTC	Dia.	28/628	313/710 315/711	3/605 4/606	10/612 10B/613	Stock PC 10BE	32D/630	32/629	32D316	32316
RM201	12"	1 1/4"	167	191	282	297	240	172	210	232	271
RM202	18"	1 1/4"	183	209	314	329	261	191	230	256	294
RM203	24"	1 1/4"	197	225	345	361	281	210	248	286	325
RM204	36"	1 1/4"	231	257	414	431	342	235	276	316	356
RM221	12"	1 1/2"	216	237	337	361	267	197	248	278	310
RM222	18"	1 1/2"	231	248	375	393	330	223	276	316	353
RM223	24"	1 1/2"	248	264	423	438	355	246	303	351	391
RM224	36"	1 1/2"	281	297	499	516	388	279	334	395	440

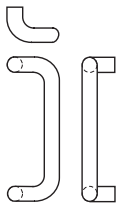

RM201

Push Bars - Add \$6/in. per bar for extra length bars over 36".											
Part	CTC	Dia.	28/628	313/710 315/711	3/605 4/606	10/612 10B/613	Stock PC 10BE	32D/630	32/629	32D316	32316
RM350	Up to 36"	1 1/4"	216	242	314	337	267	197	220	279	286
RM370	Up to 36"	1 1/2"	248	273	375	406	349	240	269	341	381

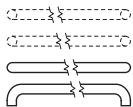

RM350

Straight Push Pull Sets - Specify Push Bar CTC. Add \$6/in. per bar for extra length bars over 36".											
Part	CTC	Dia.	28/628	313/710 315/711	3/605 4/606	10/612 10B/613	Stock PC 10BE	32D/630	32/629	32D316	32316
RM351	12"	1 1/4"	342	384	551	594	472	357	401	507	521
RM352	18"	1 1/4"	351	391	583	629	485	370	414	525	535
RM371	12"	1 1/2"	424	465	661	714	538	420	470	595	666
RM372	18"	1 1/2"	448	489	683	737	590	445	499	633	706

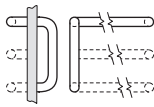

RM352

Offset Push Pull Sets - Specify Push Bar CTC. Add \$6/in. per bar for extra length bars over 36".											
Part	CTC	Dia.	28/628	313/710 315/711	3/605 4/606	10/612 10B/613	Stock PC 10BE	32D/630	32/629	32D316	32316
RM251	12"	1 1/4"	402	448	613	661	501	385	431	545	575
RM252	18"	1 1/4"	415	465	644	695	518	401	449	569	595
RM271	12"	1 1/2"	480	522	730	789	597	452	506	641	715
RM272	18"	1 1/2"	501	539	769	831	623	478	534	676	754

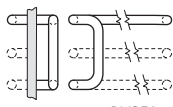

RM251

Heavy Duty 30° Offset Pulls											
Part	CTC	Dia.	28/628	313/710 315/711	3/605 4/606	10/612 10B/613	Stock PC 10BE	32D/630	32/629	32D316	32316
RM257	10"	1 1/4"	176	191	379	410	356	248	278	351	386
RM258	12"	1 1/4"	191	209	406	439	379	270	304	383	410
RM259	18"	1 1/4"	197	216	448	484	409	298	333	423	443

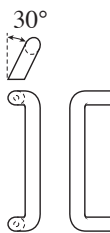

RM257

NOTE: Engraving "Push" or "Pull" add \$103.00 (1/2" letter height).

NOTE: Post location on push bars can be located 1/8" from end for narrow & medium stile doors and 1" from end for flush and wide stile doors.

## RightAngles - with or without GripZone

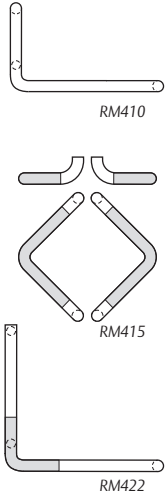

Without GripZone (RM410-RM413 specify handing and height x width when ordering.)									
Part	28/628	313/710 315/711	3/605 4/606	10/612 10B/613	Stock PC 10BE	32D/630	32/629	32D316	32316
<b>RM405-15</b>	265	300	427	462	371	222	250	312	354
<b>RM410</b> (leg up)	547	629	914	987	689	458	526	646	744
<b>RM411</b> (leg down)	547	629	914	987	689	458	526	646	744
<b>RM412</b> (leg up)	930	1,063	1,032	1,116	1,073	776	888	1,098	1,256
<b>RM413</b> (leg down)	930	1,063	1,032	1,116	1,073	776	888	1,098	1,256
With GripZone (RM420-RM423 specify handing and height x width when ordering.)									
Part	3/605	9/611	32/629	32316					
<b>RM415-15</b>	587	678	434	789					
<b>RM420</b> (leg up)	1,155	1,324	848	1,538					
<b>RM421</b> (leg down)	1,155	1,324	848	1,538					
<b>RM422</b> (leg up)	1,492	1,716	1,083	1,996					
<b>RM423</b> (leg down)	1,492	1,716	1,083	1,996					

## Small Pulls - for Cabinets, Casework and Closets

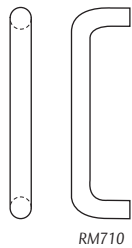

Wire Pulls - without base plates								
Part	CTC	Dia.	3/605 4/606	10B/613	Stock PC 10BE	26/625 26D/626	32D/630	32/629
<b>RM710-4</b>	4"	3/8"	37	40	39	37	23	25
<b>RM710-5</b>	5"	3/8"	38	41	40	38	24	26
<b>RM710-6</b>	6"	3/8"	40	43	42	41	25	29
<b>RM720-4</b>	4"	1/2"	45	49	45	45	25	29
<b>RM720-5</b>	5"	1/2"	46	50	47	46	26	31
<b>RM720-6</b>	6"	1/2"	48	51	49	48	29	33
<b>RM730-5</b>	5"	5/8"	52	56	51	52	31	34
<b>RM730-6</b>	6"	5/8"	54	57	52	54	32	35
<b>RM730-7</b>	7"	5/8"	55	60	53	55	33	36

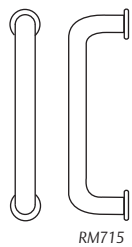

Wire Pulls - with base plates								
Part	CTC	Dia.	3/605 4/606	10B/613	Stock PC 10BE	26/625 26D/626	32D/630	32/629
<b>RM715-4</b>	4"	3/8"	57	61	61	57	43	47
<b>RM715-5</b>	5"	3/8"	60	65	64	60	45	49
<b>RM715-6</b>	6"	3/8"	61	66	65	64	46	53
<b>RM725-4</b>	4"	1/2"	69	73	68	69	47	54
<b>RM725-5</b>	5"	1/2"	70	74	69	70	48	55
<b>RM725-6</b>	6"	1/2"	71	77	70	71	49	56
<b>RM735-5</b>	5"	5/8"	74	81	70	74	49	56
<b>RM735-6</b>	6"	5/8"	77	83	73	77	52	58
<b>RM735-7</b>	7"	5/8"	78	85	74	78	53	59

## Flush Pulls

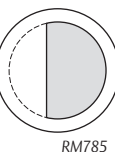
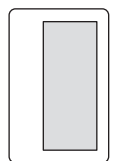

Flush Pulls					
Part	Size	3/605 4/606	10B/613	Stock PC 10BE	26/625 26D/626
<b>RM780</b>	2 3/16" x 3 1/4"	39	42	43	42
<b>RM782</b>	2 11/16" x 4 3/16"	42	45	46	45
<b>RM785</b>	3 1/2" Dia.	53	57	57	56

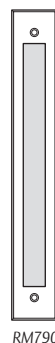

Flush Cup Pull				
Part	OA	Stock PC 10BE	32D/630	32/629
<b>RM790</b>	14"	170	117	130
	26"	201	138	155
	38"	217	164	184

NOTE: If ordering pull to mate with this product, the CTC of the pull needs to be 2" less than the overall of the flush pull.

Order form available when ordering.

**ASSA ABLOY**

Experience a safer  
and more open world

Edge Pulls - for Closet Doors

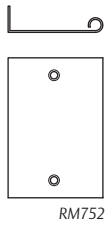

Square Edge Door						
Part	Max OA	3/605 4/606	10/612 10B/613	Stock PC 10BE	32D/630	32/629
RM751	Up to 12"	98	105	96	77	85
RM752	Up to 12"	101	108	99	80	88

Bevel Edge Door						
RM753	Up to 12"	103	111	102	82	92
RM754	Up to 12"	105	113	105	85	96

Double Edge Pull - Square Edge						
RM755	Up to 12"	192	208	174	153	172

Concealed Edge Pull						
Part	Size	3/605 4/606	10/612 10B/613	Stock PC 10BE	26/625 26D/626	32/629
RM760	1" x 4 1/4"	52	56	55	56	

- Specifying Information: 1. Select style pull number; 2. Select standard length [2", 2 1/2", 3", 4", 5", 6", 12" (max)]; 3. Specify door thickness [Example: RM752-4" 32D 1 3/4" door]
- \* RM760 cannot be modified.

Order form available when ordering.

Coat Hooks

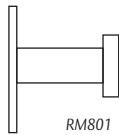

Part	Size	3/605 4/606	10B/613	Stock PC 10BE	26/625 26D/626	32D/630
RM801	1 1/4" x 1 3/4"	68	72	71	71	52
RM802	1 1/4" x 2 3/4"	69	73	72	72	55
RM803	1" x 2"	68	72	71		67
RM804	1" x 3"	69	73	72		68
RM805	1" x 1 3/4"	84	92	90	92	
RM806	1" x 3"	92	101	98	101	
RM807	1 1/4" x 2 3/4"	103	111	109	111	
RM808	1 1/4" x 3 1/2"	111	120	118	118	
RM811	3/4" x 1 1/2"	46	49	48	46	
RM812	1 1/4" x 2 1/4"	48	52	51	48	

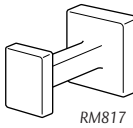

Part	Size	Stock PC/10BE	15/619
RM817	Square 1 3/4", 2 11/16" Projection	53	52

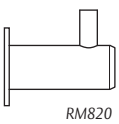

Part	Size	3/605 4/606	Stock PC 10BE	32D/630	32/629
RM820	1/2" x 1 5/8"		54	40	
RM821	5/8" x 2 1/8"		55	41	
RM822	1/2" x 1 1/2"		39	27	
RM823	5/8" x 2"		41	28	
RM828	3/4"W x 2 7/8"	80	65	52	72
RM829	3/4"W x 1 7/8"	72	63	66	68

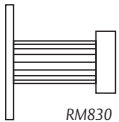

LineaMet Coat Hooks						
RM830 (w/base plate)	1 1/4" x 2 1/4"		84	61	66	
RM831	5/8" x 2 1/8"		84	61	66	

ArborMet Coat Hooks						
RM835 (w/base plate)	1 1/4" x 2 1/4"		84	61	66	
RM836	5/8" x 2 1/8"		84	61	66	



SoftMet Coat Hooks						
RM838 (w/base plate)	1 1/4" x 2 1/4"		84	61	66	
RM839	5/8" x 2 1/8"		84	61	66	

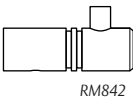

Groove Coat Hooks						
RM840 (w/base plate)	1/2" x 1 5/8"		69	48		
RM841 (w/base plate)	5/8" x 2 1/8"		72	51		
RM842	1/2" x 1 1/2"		60	40		
RM843	5/8" x 2"		63	42		



Door Stops

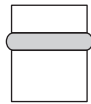

RM850

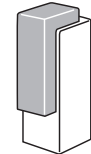

RM857

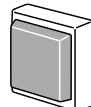

RM867

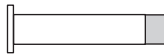

RM876

Floor Mounted						
Part	Height	3/605 4/606	10/612 10B/613	Stock PC 10BE	26/625 26D/626	32D/630
RM850	1 1/2"	45	49	48	41	38
RM851	2 1/2"	57	63	61	57	50
RM855	1 3/4"	50	54	52	46	44
RM856	2 3/4"	61	66	65	61	53
Part	Size				Stock PC 10BE	15/619
RM857	Square 1" Base, 2 3/4" Projection				65	64

Black bumpers available. Suffix BB after part number.Ex:) RM850BB.32D Add on charge will apply.

Wall Mounted						
Part	Projection	3/605 4/606	10/612 10B/613	Stock PC 10BE	26/625 26D/626	32D/630
RM860	1 3/32"	29	31	31	28	23
RM861	1 3/32"	29	31	31	28	23
Part	Size				Stock PC 10BE	15/619
RM867	Square 1 3/4" Base, 3/4" Projection				51	50

Base Board Mounted						
Part	Projection	3/605 4/606	10/612 10B/613	Stock PC 10BE	26/625 26D/626	32D/630
RM870	1 1/2"	40	43	42	37	26
RM871	3 1/4"	40	43	42	37	26
RM872	3 3/4"	40	43	42	37	26
RM875	1 1/2"	56	60	58	56	41
RM876	3 1/4"	56	60	58	56	41
RM877	3 3/4"	56	60	58	56	41

Push Plates, Pull Plates and Signage



RM1010



RM1030



RM1120H



RM1120L

Square Corner - Adhesive Mount						
Part	Size	3/605 4/606	10/612 10B/613	Stock PC 10BE	32D/630	32/629
RM1010	4" x 22"				58	64
RM1010H	4" x 22"				86	97
RM1010L	4" x 22"				86	97

Square Corner - Screw Mount						
Part	Size	3/605 4/606	10/612 10B/613	Stock PC 10BE	32D/630	32/629
RM1020	4" x 22"	90	99	69	42	48
RM1020H	4" x 22"	126	138	102	73	82
RM1020L	4" x 22"	126	138	102	73	82

Radius End Corner - Adhesive Mount						
Part	Size	3/605 4/606	10/612 10B/613	Stock PC 10BE	32D/630	32/629
RM1030	4" x 22"				73	82
RM1030H	4" x 22"				102	114
RM1030L	4" x 22"				102	114

Radius End Corner - Screw Mount						
Part	Size	3/605 4/606	10/612 10B/613	Stock PC 10BE	32D/630	32/629
RM1040	4" x 22"	109	120	85	58	64
RM1040H	4" x 22"	144	157	116	86	97
RM1040L	4" x 22"	144	157	116	86	97

Indicator Plates - Adhesive Mount						
Part	Size	3/605 4/606	10/612 10B/613	Stock PC 10BE	32D/630	32/629
RM1110H	1" Dia.	74	85	83	61	68
RM1110L	1" Dia.	74	85	83	61	68
RM1120H	2 1/2" Dia.	74	85	83	61	68
RM1120L	2 1/2" Dia.	74	85	83	61	68
RM1150M	2" x 4"	80	92	88	68	77
RM1150W	2" x 5 3/4"	83	95	90	71	79

Indicator Plates - Screw Mount						
Part	Size	3/605 4/606	10/612 10B/613	Stock PC 10BE	32D/630	32/629
RM1160M	2" x 4"	80	92	88	68	77
RM1160W	2" x 5 3/4"	83	95	90	71	79

ASSA ABLOY

Experience a safer  
and more open world

MegaTek - Small Pulls for Cabinets, Casework & Closet Doors

Straight - Flat Ends								
Part	Max OA	Dia.	3/605 4/606	10/612	10B/613	Stock PC 10BE	32D/630	32/629
RM1200-4	5 7/8"	1/2"	60		65	51	25	29
RM1200-5	6 7/8"	1/2"	61		68	52	26	30
RM1200-6	7 7/8"	1/2"	63		69	65	37	44
RM1200-8	9 7/8"	1/2"	66		71	69	43	47
RM1200-10	11 7/8"	1/2"	70		74	73	46	50
RM1200-12	13 7/8"	1/2"	78		86	76	49	56
RM1200-18	19 7/8"	1/2"	105		113	81	53	60
RM1200-24	25 7/8"	1/2"	120		130	92	64	73
RM1200-30	31 7/8"	1/2"	142		153	104	75	83
RM1210-5	6 7/8"	5/8"	80		85	64	36	42
RM1210-6	7 7/8"	5/8"	81		86	68	41	46
RM1210-7	8 7/8"	5/8"	81		87	74	47	53
RM1210-8	9 7/8"	5/8"	83		89	76	49	56
RM1210-10	11 7/8"	5/8"	94		103	78	50	58
RM1210-12	13 7/8"	5/8"	101		108	81	53	60
RM1210-18	19 7/8"	5/8"	139		149	96	70	78
RM1210-24	25 7/8"	5/8"	158		171	108	79	89
RM1210-30	31 7/8"	5/8"	189		206	116	86	96
Offset - Flat Ends								
RM1230-5	6 7/8"	5/8"				107	78	87
RM1230-6	7 7/8"	5/8"				108	79	88
RM1230-7	8 7/8"	5/8"				110	82	90
RM1230-8	9 7/8"	5/8"				114	85	96
RM1230-10	11 7/8"	5/8"				116	86	97
RM1230-12	13 7/8"	5/8"				118	88	99
RM1230-18	19 7/8"	5/8"				142	100	112
RM1230-24	25 7/8"	5/8"				157	113	126
RM1230-30	31 7/8"	5/8"				161	118	132
Straight - Round Ends								
RM1240-4	5 7/8"	1/2"	71	77	77	71	45	50
RM1240-5	6 7/8"	1/2"	72	78	78	73	46	52
RM1240-6	7 7/8"	1/2"	73	80	80	74	47	53
RM1240-8	9 7/8"	1/2"	76	83	83	78	50	56
RM1240-10	11 7/8"	1/2"	78	86	86	83	55	62
RM1240-12	13 7/8"	1/2"	85	90	90	88	60	67
RM1240-18	19 7/8"	1/2"	109	120	120	105	64	72
RM1240-24	25 7/8"	1/2"	129	139	139	111	72	80
RM1240-30	31 7/8"	1/2"	144	157	157	124	83	92
RM1250-5	6 7/8"	5/8"	85		90	83	55	62
RM1250-6	7 7/8"	5/8"	87		94	84	56	63
RM1250-7	8 7/8"	5/8"	89		98	85	58	64
RM1250-8	9 7/8"	5/8"	92		100	87	59	66
RM1250-10	11 7/8"	5/8"	103		109	89	61	68
RM1250-12	13 7/8"	5/8"	107		117	91	63	71
RM1250-18	19 7/8"	5/8"	142		155	104	75	84
RM1250-24	25 7/8"	5/8"	164		176	116	86	98
RM1250-30	31 7/8"	5/8"	192		207	121	92	102
Offset - Round Ends								
RM1270-5	6 7/8"	5/8"				118	89	99
RM1270-6	7 7/8"	5/8"				119	89	100
RM1270-7	8 7/8"	5/8"				120	90	101
RM1270-8	9 7/8"	5/8"				123	93	103
RM1270-10	11 7/8"	5/8"				124	95	105
RM1270-12	13 7/8"	5/8"				127	97	108
RM1270-18	19 7/8"	5/8"				142	111	124
RM1270-24	25 7/8"	5/8"				152	121	134
RM1270-30	31 7/8"	5/8"				157	125	139

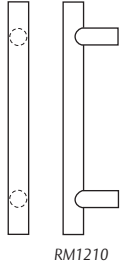

RM1210

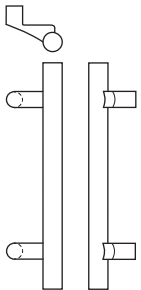

RM1230

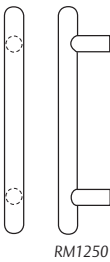

RM1250

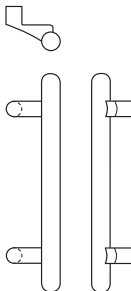

RM1270

**ASSA ABLOY**

Experience a safer  
and more open world

Groove - Small Pulls

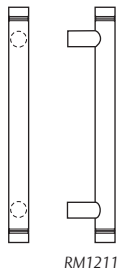

RM1211

Straight - Flat Ends							
Part	Max OA	Dia.	3/605 4/606	10/612 10B/613	Stock PC 10BE	32D/630	32/629
RM1211-5	6 7/8"	5/8"	88	95	83	55	62
RM1211-6	7 7/8"	5/8"	89	96	84	56	63
RM1211-7	8 7/8"	5/8"	90	98	85	58	64
RM1211-8	9 7/8"	5/8"	92	100	87	59	66
RM1211-10	11 7/8"	5/8"	101	108	88	60	67
RM1211-12	13 7/8"	5/8"	106	116	91	63	71

GripZone - Small Pulls for Cabinets, Casework & Closet Doors

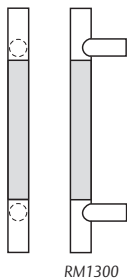

RM1300

Straight - Flat Ends			
Part	Max OA	Dia.	32/629
RM1300-4	5 7/8"	1/2"	64
RM1300-5	6 7/8"	1/2"	66
RM1300-6	7 7/8"	1/2"	67
RM1300-8	9 7/8"	1/2"	68
RM1300-10	11 7/8"	1/2"	71
RM1300-12	13 7/8"	1/2"	76
RM1300-18	19 7/8"	1/2"	80
RM1300-24	25 7/8"	1/2"	92
RM1300-30	31 7/8"	1/2"	101

Straight - Flat Ends			
RM1310-5	6 7/8"	5/8"	73
RM1310-6	7 7/8"	5/8"	74
RM1310-7	8 7/8"	5/8"	75
RM1310-8	9 7/8"	5/8"	76
RM1310-10	11 7/8"	5/8"	78
RM1310-12	13 7/8"	5/8"	80
RM1310-18	19 7/8"	5/8"	97
RM1310-24	25 7/8"	5/8"	107
RM1310-30	31 7/8"	5/8"	120

Offset - Flat Ends			
RM1330-5	6 7/8"	5/8"	107
RM1330-6	7 7/8"	5/8"	108
RM1330-7	8 7/8"	5/8"	109
RM1330-8	9 7/8"	5/8"	113
RM1330-10	11 7/8"	5/8"	115
RM1330-12	13 7/8"	5/8"	120
RM1330-18	19 7/8"	5/8"	132
RM1330-24	25 7/8"	5/8"	145
RM1330-30	31 7/8"	5/8"	154

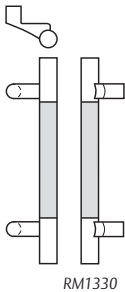

RM1330

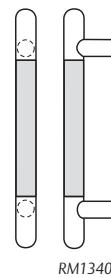

RM1340

Straight - Round Ends			
Part	Max OA	Dia.	32/629
RM1340-4	5 7/8"	1/2"	74
RM1340-5	6 7/8"	1/2"	75
RM1340-6	7 7/8"	1/2"	76
RM1340-8	9 7/8"	1/2"	78
RM1340-10	11 7/8"	1/2"	80
RM1340-12	13 7/8"	1/2"	88
RM1340-18	19 7/8"	1/2"	95
RM1340-24	25 7/8"	1/2"	101
RM1340-30	31 7/8"	1/2"	113

Straight - Round Ends			
RM1350-5	6 7/8"	5/8"	85
RM1350-6	7 7/8"	5/8"	86
RM1350-7	8 7/8"	5/8"	87
RM1350-8	9 7/8"	5/8"	88
RM1350-10	11 7/8"	5/8"	92
RM1350-12	13 7/8"	5/8"	95
RM1350-18	19 7/8"	5/8"	107
RM1350-24	25 7/8"	5/8"	120
RM1350-30	31 7/8"	5/8"	128

Offset - Round Ends			
RM1370-5	6 7/8"	5/8"	120
RM1370-6	7 7/8"	5/8"	121
RM1370-7	8 7/8"	5/8"	122
RM1370-8	9 7/8"	5/8"	124
RM1370-10	11 7/8"	5/8"	126
RM1370-12	13 7/8"	5/8"	128
RM1370-18	19 7/8"	5/8"	145
RM1370-24	25 7/8"	5/8"	154
RM1370-30	31 7/8"	5/8"	167

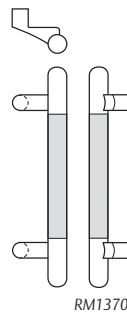

RM1370

GROOVE / SMALL PULLS (w/GRIPZONE)

RM1211-RM1370

ASSA ABLOY

Experience a safer  
and more open world



NoirMet - Small Pulls

Straight - Flat Ends								
Part	Max OA	Dia.	3/605 4/606	10/612 10B/613	Stock PC 10BE	32D/630	32/629	
RM1410-5	6 7/8"	5/8"	139	151	104	75	83	
RM1410-6	7 7/8"	5/8"	142	155	106	77	86	
Offset - Flat Ends								
RM1430-5	6 7/8"	5/8"			149	118	133	
RM1430-6	7 7/8"	5/8"			152	121	135	
Straight - Round Ends								
RM1450-5	6 7/8"	5/8"	165	178	123	93	103	
RM1450-6	7 7/8"	5/8"	169	180	127	97	107	
Offset - Round Ends								
RM1470-5	6 7/8"	5/8"			171	137	154	
RM1470-6	7 7/8"	5/8"			176	142	161	

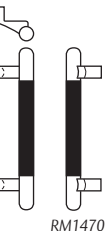

ArborMet - Small Pulls

Straight - Flat Ends								
Part	Max OA	Dia.	3/605 4/606	10/612 10B/613	Stock PC 10BE	32D/630	32/629	
RM1510-5	6 7/8"	5/8"	146	158	108	79	90	
RM1510-6	7 7/8"	5/8"	149	161	111	83	95	
Offset - Flat Ends								
RM1530-5	6 7/8"	5/8"			157	125	141	
RM1530-6	7 7/8"	5/8"			160	128	148	
Straight - Round Ends								
RM1550-5	6 7/8"	5/8"	172	186	131	101	114	
RM1550-6	7 7/8"	5/8"	176	189	135	104	120	
Offset - Round Ends								
RM1570-5	6 7/8"	5/8"			178	146	166	
RM1570-6	7 7/8"	5/8"			181	148	171	

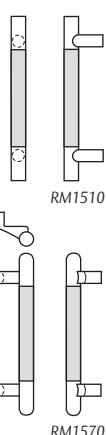

MegaCurve - Long Curved Pulls

Mid Bow								
Part	Max OA	3/605 4/606	10/612 10B/613	Stock PC 10BE	32D/630	32/629	32D316	32316
RM2000	72"	1,941	2,097	1,418	1,197	1,342	1,695	1,891
	84"	2,006	2,167	1,479	1,256	1,406	1,778	1,983
	96"	2,070	2,236	1,541	1,315	1,473	1,861	2,076
RM2004	72"	2,063	2,227	1,522	1,297	1,453	1,836	2,048
	84"	2,126	2,297	1,585	1,355	1,517	1,919	2,140
	96"	2,191	2,366	1,646	1,413	1,584	2,001	2,232
Long Bow Pulls								
RM2010	72"	2,544	2,746	1,945	1,695	1,852	2,340	2,611
	84"	2,608	2,816	2,007	1,712	1,917	2,422	2,703
	96"	2,671	2,885	2,069	1,770	1,983	2,506	2,795
RM2014	72"	2,667	2,880	2,050	1,795	2,010	2,540	2,833
	84"	2,732	2,950	2,113	1,853	2,076	2,623	2,925
	96"	2,795	3,019	2,174	1,912	2,140	2,706	3,017
45° Pulls								
RM2020	72"	2,063	2,227	1,522	1,297	1,453	1,836	2,048
	84"	2,126	2,297	1,585	1,355	1,517	1,919	2,140
	96"	2,191	2,366	1,646	1,413	1,584	2,001	2,232
RM2024	72"	2,184	2,359	1,628	1,396	1,564	1,976	2,204
	84"	2,248	2,427	1,690	1,455	1,630	2,059	2,297
	96"	2,312	2,497	1,752	1,513	1,694	2,142	2,389
Triangle Pulls								
RM2030	72"	2,063	2,227	1,522	1,297	1,453	1,836	2,048
	84"	2,126	2,297	1,585	1,355	1,517	1,919	2,140
	96"	2,191	2,366	1,646	1,413	1,584	2,001	2,232
RM2034	72"	2,184	2,359	1,628	1,396	1,564	1,976	2,204
	84"	2,248	2,427	1,690	1,455	1,630	2,059	2,297
	96"	2,312	2,497	1,752	1,513	1,694	2,142	2,389

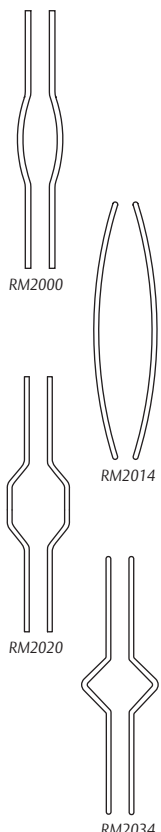

• Add \$6.50/in. over 96".

**ASSA ABLOY**

Experience a safer  
and more open world

## MezzoTek - Necked Post Pulls

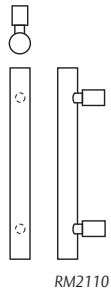

Straight Pulls without GripZone									
Part	Max OA	Dia.	3/605 4/606	10/612 10B/613	Stock PC 10BE	32D/630	32/629	32D316	32316
RM2110	12"	1 1/4"	558	604	331	223	250	316	353
	24"	1 1/4"	604	652	390	279	312	395	441
	36"	1 1/4"	649	701	448	334	374	474	529
	48"	1 1/4"	693	749	508	390	437	553	617
	60"	1 1/4"	723	780	547	426	478	606	674
	72"	1 1/4"	753	813	608	463	519	658	732
	84"	1 1/4"	783	845	648	500	561	710	791
	96"	1 1/4"	812	877	687	537	602	762	850
RM2120	12"	1 1/2"	607	655	343	235	263	334	371
	24"	1 1/2"	652	704	403	291	326	412	460
	36"	1 1/2"	696	753	462	346	388	491	548
	48"	1 1/2"	742	801	520	402	450	569	636
	60"	1 1/2"	772	833	559	438	491	621	692
	72"	1 1/2"	801	866	621	475	531	673	751
	84"	1 1/2"	831	898	660	512	572	725	808
	96"	1 1/2"	861	930	699	548	615	778	866

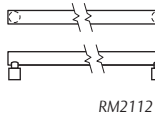

Push Bars without GripZone									
RM2112	Up to 36" CTC	1 1/4"	649	701	448	334	374	474	529
RM2122	Up to 36" CTC	1 1/2"	696	753	462	346	388	491	548

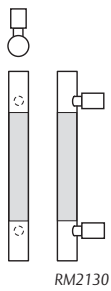

Straight Pulls with GripZone									
Part	Max OA	Dia.	3/605	9/611	32/629	32316			
RM2130	12"	1 1/4"	677	765	361	520			
	24"	1 1/4"	722	815	423	608			
	36"	1 1/4"	766	867	487	696			
	48"	1 1/4"	812	917	548	781			
	60"	1 1/4"	842	952	590	837			
	72"	1 1/4"	871	985	630	895			
	84"	1 1/4"	901	1,019	672	951			
	96"	1 1/4"	931	1,052	713	1,009			
RM2140	12"	1 1/2"	725	820	374	571			
	24"	1 1/2"	771	871	437	670			
	36"	1 1/2"	815	921	499	768			
	48"	1 1/2"	861	972	562	866			
	60"	1 1/2"	889	1,007	602	931			
	72"	1 1/2"	919	1,040	643	997			
	84"	1 1/2"	950	1,072	684	1,061			
	96"	1 1/2"	979	1,106	726	1,128			

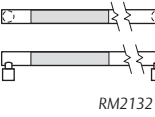

Push Bars with GripZone									
RM2132	Up to 36" CTC	1 1/4"	766	867	487	696			
RM2142	Up to 36" CTC	1 1/2"	815	921	499	768			

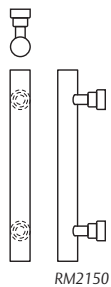

Double Stepped Post Pulls									
Part	Max OA	Dia.	3/605 4/606	10/612 10B/613	Stock PC 10BE	32D/630	32/629	32D316	32316
RM2150	12"	1"	432	467	354	244	275	347	387
	24"	1"	501	542	413	301	337	426	475
	36"	1"	570	616	472	356	399	505	564
	48"	1"	639	690	531	413	462	584	652
	60"	1"	707	764	595	449	503	637	710
	72"	1"	776	838	633	487	544	689	768
	84"	1"	845	913	672	523	586	742	826
	96"	1"	914	987	711	560	626	794	885

- Add \$6.50/in. over 96".
- MP (Mid Post) - Add \$76 each (Recommended for maximum rigidity on long door pulls. See page 5 for guidelines.)
- Pulls with GripZone offer an additional aesthetic look, not a tactile feel. The grip zones are satin, the post and end sections are polished. US10B finish is not available on GripZone pulls.

NOTE: Post location on push bars can be located 1/8" from end for narrow & medium stile doors and 1" from end for flush and wide stile doors.

**ASSA ABLOY**

Experience a safer  
and more open world

BandWidth - Collar Mount Pulls

Straight Pulls - Flat Ends								
Part	Max OA	Dia.	3/605 4/606	10/612 10B/613	Stock PC 10BE	32D/630	32/629	
<b>RM2200</b>	12"	1"	565	611	510	389	435	
	24"	1"	657	708	557	433	486	
	36"	1"	750	809	628	477	534	
	48"	1"	842	909	674	521	583	
	60"	1"	934	1,008	706	549	616	
	72"	1"	1,025	1,108	736	579	648	
	84"	1"	1,118	1,207	766	608	680	
	96"	1"	1,211	1,307	797	636	713	
	<b>RM2210</b>	12"	1 1/4"	605	653	525	401	450
		24"	1 1/4"	694	750	570	445	499
36"		1 1/4"	784	847	641	490	548	
48"		1 1/4"	872	942	687	532	597	
60"		1 1/4"	961	1,040	718	562	628	
72"		1 1/4"	1,052	1,134	748	591	660	
84"		1 1/4"	1,141	1,232	779	620	694	
96"		1 1/4"	1,230	1,329	809	648	726	
Offset Pulls - Flat Ends								
<b>RM2230</b>		12"	1"	616	665	552	428	479
	24"	1"	707	765	623	473	529	
	36"	1"	800	864	670	517	579	
	48"	1"	894	964	717	560	627	
	60"	1"	984	1,063	747	590	659	
	72"	1"	1,077	1,163	778	619	693	
	84"	1"	1,168	1,262	808	647	725	
	96"	1"	1,261	1,362	840	676	757	
	<b>RM2240</b>	12"	1 1/4"	656	707	565	441	495
		24"	1 1/4"	744	803	637	486	543
36"		1 1/4"	834	902	684	529	593	
48"		1 1/4"	922	996	729	571	640	
60"		1 1/4"	1,013	1,094	759	601	672	
72"		1 1/4"	1,101	1,190	791	630	705	
84"		1 1/4"	1,191	1,286	820	658	737	
96"		1 1/4"	1,280	1,382	851	688	770	

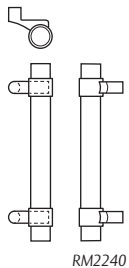
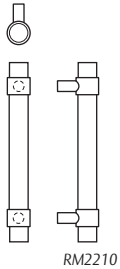

- Add \$6.50/in. over 96".
- MP (Mid Post) - Add \$108 each (Recommended for maximum rigidity on long door pulls. See page 5 for guidelines.)
- Specify finish of grip and collar.

NOTE: Post location on push bars can be located 1/8" from end for narrow & medium stile doors and 1" from end for flush and wide stile doors.

BandWidth - Collar Mount Pulls (con't)

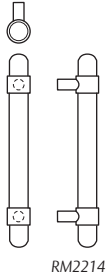

Straight Pulls - Round Ends							
Part	Max OA	Dia.	3/605 4/606	10/612 10B/613	Stock PC 10BE	32D/630	32/629
<b>RM2204</b>	12"	1"	672	726	560	435	488
	24"	1"	765	826	630	479	537
	36"	1"	858	925	676	523	587
	48"	1"	950	1,025	724	567	635
	60"	1"	1,041	1,125	755	597	668
	72"	1"	1,133	1,225	784	625	701
	84"	1"	1,226	1,324	816	654	733
	96"	1"	1,318	1,424	846	683	764
	<b>RM2214</b>	12"	1 1/4"	713	770	573	448
24"		1 1/4"	801	866	644	492	551
36"		1 1/4"	890	961	690	536	601
48"		1 1/4"	981	1,059	736	579	648
60"		1 1/4"	1,070	1,156	766	608	680
72"		1 1/4"	1,159	1,251	797	636	713
84"		1 1/4"	1,249	1,348	828	666	746
96"		1 1/4"	1,338	1,444	859	695	778

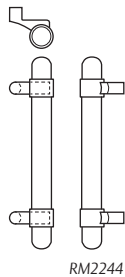

Offset Pulls - Round Ends							
<b>RM2234</b>	12"	1"	723	781	625	475	531
	24"	1"	815	880	672	519	581
	36"	1"	908	981	719	563	630
	48"	1"	1,000	1,080	765	607	679
	60"	1"	1,092	1,179	796	635	712
	72"	1"	1,184	1,278	827	665	745
	84"	1"	1,276	1,379	858	694	777
	96"	1"	1,370	1,478	888	723	809
	<b>RM2244</b>	12"	1 1/4"	763	825	639	488
24"		1 1/4"	852	920	686	531	595
36"		1 1/4"	942	1,018	732	575	645
48"		1 1/4"	1,030	1,113	778	619	693
60"		1 1/4"	1,120	1,211	808	647	725
72"		1 1/4"	1,209	1,306	840	676	757
84"		1 1/4"	1,300	1,403	869	705	790
96"		1 1/4"	1,388	1,499	900	734	822

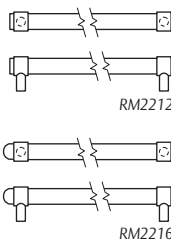

Push Bars - Flat Ends							
<b>RM2202</b>	Up to 36" CTC	1"	750	809	628	477	534
<b>RM2212</b>	Up to 36" CTC	1 1/4"	784	847	641	490	548
Push Bars - Round Ends							
<b>RM2206</b>	Up to 36" CTC	1"	858	925	676	523	587
<b>RM2216</b>	Up to 36" CTC	1 1/4"	890	961	690	536	601

- Add \$6.50/in. over 96".
- MP (Mid Post) - Add \$108 each (Recommended for maximum rigidity on long door pulls. See page 5 for guidelines.)
- Specify finish of grip and collar.

NOTE: Post location on push bars can be located 1/8" from end for narrow & medium stile doors and 1" from end for flush and wide stile doors.

**ASSA ABLOY**

Experience a safer  
and more open world

OvalTek - True Oval Grip

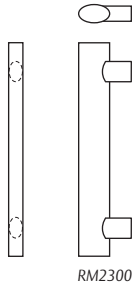

RM2300

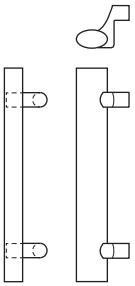

RM2320



RM2302

Straight Pulls					
Part	Max OA	Size	Stock PC 10BE	32D/630	32/629
<b>RM2300</b>	12"	1" x 1 1/2"	484	364	409
	24"	1" x 1 1/2"	546	423	474
	36"	1" x 1 1/2"	632	483	540
	48"	1" x 1 1/2"	693	540	605
	60"	1" x 1 1/2"	756	599	670
	72"	1" x 1 1/2"	818	657	736
	84"	1" x 1 1/2"	880	716	802
	96"	1" x 1 1/2"	941	774	866
Offset Pulls					
<b>RM2320</b>	12"	1" x 1 1/2"	527	405	453
	24"	1" x 1 1/2"	613	463	519
	36"	1" x 1 1/2"	674	522	584
	48"	1" x 1 1/2"	737	580	650
	60"	1" x 1 1/2"	798	639	716
	72"	1" x 1 1/2"	861	698	780
	84"	1" x 1 1/2"	922	755	847
	96"	1" x 1 1/2"	984	814	912
Straight Pulls					
<b>RM2310</b>	12"	1 1/8" x 1 7/8"	502	383	427
	24"	1 1/8" x 1 7/8"	572	448	502
	36"	1 1/8" x 1 7/8"	667	515	576
	48"	1 1/8" x 1 7/8"	738	582	651
	60"	1 1/8" x 1 7/8"	808	648	726
	72"	1 1/8" x 1 7/8"	878	714	801
	84"	1 1/8" x 1 7/8"	950	781	875
	96"	1 1/8" x 1 7/8"	1,020	848	950
Offset Pulls					
<b>RM2330</b>	12"	1 1/8" x 1 7/8"	544	422	473
	24"	1 1/8" x 1 7/8"	639	489	547
	36"	1 1/8" x 1 7/8"	710	554	622
	48"	1 1/8" x 1 7/8"	780	622	697
	60"	1 1/8" x 1 7/8"	850	688	771
	72"	1 1/8" x 1 7/8"	921	754	846
	84"	1 1/8" x 1 7/8"	992	822	920
	96"	1 1/8" x 1 7/8"	1,062	887	993
Push Bars					
<b>RM2302</b>	Up to 36" CTC	1" x 1 1/2"	632	483	540
<b>RM2312</b>	Up to 36" CTC	1 1/8" x 1 7/8"	667	515	576

- RM2310 pulls add \$7.60/in. over 96".
- MP (Mid Post) - Add \$108 each (Recommended for maximum rigidity on long door pulls. See page 5 for guidelines.)

NOTE: Post location on push bars can be located 1/8" from end for narrow & medium stile doors and 1" from end for flush and wide stile doors.

**ASSA ABLOY**

Experience a safer  
and more open world



## OvalTek - Flat Oval Grip

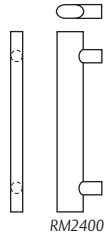

RM2400

Straight Pulls - Small Round Posts					
Part	Max OA	Size	Stock PC 10BE	32D/630	32/629
RM2400	12"	3/4" x 1 1/2"	535	414	463
	24"	3/4" x 1 1/2"	644	493	552
	36"	3/4" x 1 1/2"	728	572	641
	48"	3/4" x 1 1/2"	811	651	730
	60"	3/4" x 1 1/2"	896	730	818
	72"	3/4" x 1 1/2"	979	810	907
	84"	3/4" x 1 1/2"	1,063	888	995
	96"	3/4" x 1 1/2"	1,171	967	1,084

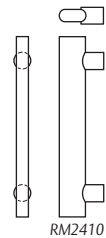

RM2410

Straight Pulls - Large Round Posts					
Part	Max OA	Size	Stock PC 10BE	32D/630	32/629
RM2410	12"	3/4" x 1 1/2"	579	453	509
	24"	3/4" x 1 1/2"	687	534	598
	36"	3/4" x 1 1/2"	771	613	686
	48"	3/4" x 1 1/2"	854	692	774
	60"	3/4" x 1 1/2"	938	771	863
	72"	3/4" x 1 1/2"	1,022	850	952
	84"	3/4" x 1 1/2"	1,130	929	1,040
	96"	3/4" x 1 1/2"	1,215	1,009	1,129

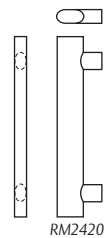

RM2420

Straight Pulls - Oblong Posts					
Part	Max OA	Size	Stock PC 10BE	32D/630	32/629
RM2420	12"	3/4" x 1 1/2"	725	569	638
	24"	3/4" x 1 1/2"	808	648	726
	36"	3/4" x 1 1/2"	891	727	814
	48"	3/4" x 1 1/2"	976	807	904
	60"	3/4" x 1 1/2"	1,060	885	991
	72"	3/4" x 1 1/2"	1,167	964	1,080
	84"	3/4" x 1 1/2"	1,252	1,044	1,169
	96"	3/4" x 1 1/2"	1,336	1,123	1,257

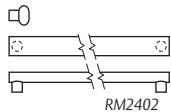





RM2402

Push Bar - Large Round Posts					
Part	Max OA	Size	Stock PC 10BE	32D/630	32/629
RM2402	Up to 36" CTC	3/4" x 1 1/2"	771	613	686

- RM2410 pulls add \$7.60/in. over 96".
- MP (Mid Post) - Add \$108 each (Recommended for maximum rigidity on long door pulls. See page 5 for guidelines.)

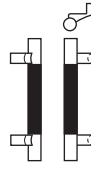

NOTE: Post location on push bars can be located 1/8" from end for narrow & medium stile doors and 1" from end for flush and wide stile doors.

SoftMet - Santoprene™ Grip

Straight Pulls - Flat Ends								
Part	Max OA	Dia.	3/605 4/606	10/612 10B/613	Stock PC 10BE	32D/630	32/629	
 RM2510	12"	1 1/4"	464	501	462	342	384	
	24"	1 1/4"	601	649	576	449	504	
	36"	1 1/4"	737	796	714	557	624	
	48"	1 1/4"	873	943	816	665	745	
	60"	1 1/4"	1,010	1,091	930	772	864	
	72"	1 1/4"	1,147	1,238	1,065	879	984	
	84"	1 1/4"	1,283	1,385	1,179	986	1,106	
Offset Pulls - Flat Ends								
 RM2540	12"	1 1/4"	510	550	506	384	430	
	24"	1 1/4"	647	697	643	491	549	
	36"	1 1/4"	781	845	758	599	670	
	48"	1 1/4"	918	991	860	706	791	
	60"	1 1/4"	1,055	1,138	973	813	911	
	72"	1 1/4"	1,191	1,287	1,109	920	1,031	
	84"	1 1/4"	1,327	1,434	1,222	1,028	1,150	
Straight Pulls - Round Ends								
 RM2514	12"	1 1/4"	568	613	511	389	436	
	24"	1 1/4"	704	760	650	497	556	
	36"	1 1/4"	840	907	763	604	676	
	48"	1 1/4"	976	1,055	865	711	797	
	60"	1 1/4"	1,113	1,202	978	818	916	
	72"	1 1/4"	1,249	1,349	1,114	926	1,037	
	84"	1 1/4"	1,385	1,497	1,227	1,033	1,156	
Offset Pulls - Round Ends								
 RM2544	12"	1 1/4"	613	661	554	430	482	
	24"	1 1/4"	749	809	693	538	602	
	36"	1 1/4"	885	956	807	645	723	
	48"	1 1/4"	1,022	1,103	908	752	842	
	60"	1 1/4"	1,159	1,251	1,044	859	962	
	72"	1 1/4"	1,295	1,398	1,158	966	1,082	
	84"	1 1/4"	1,431	1,545	1,271	1,073	1,202	
Push Bars								
 RM2512	RM2512	Up to 36" CTC	1 1/4"	737	796	714	557	624
	RM2516	Up to 36" CTC	1 1/4"	840	907	763	604	676

NOTE: Post location on push bars can be located 1/8" from end for narrow & medium stile doors and 1" from end for flush and wide stile doors.

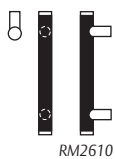
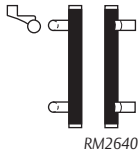
SoftTek - Santoprene™ Grip

Straight Pulls								
Part	Max OA	Dia.	3/605 4/606	10/612 10B/613	Stock PC 10BE	32D/630	32/629	
 RM2610	12"	1 1/4"	418	452	448	330	369	
	24"	1 1/4"	547	590	558	433	485	
	36"	1 1/4"	676	729	691	535	600	
	48"	1 1/4"	805	869	787	638	714	
	60"	1 1/4"	934	1,008	896	740	830	
	72"	1 1/4"	1,062	1,148	1,027	843	944	
	84"	1 1/4"	1,191	1,286	1,136	946	1,061	
Offset Pulls								
 RM2640	12"	1 1/4"	463	500	492	371	415	
	24"	1 1/4"	591	639	625	474	530	
	36"	1 1/4"	721	778	735	575	645	
	48"	1 1/4"	849	917	830	678	760	
	60"	1 1/4"	978	1,057	939	781	875	
	72"	1 1/4"	1,107	1,196	1,071	884	990	
	84"	1 1/4"	1,236	1,336	1,180	987	1,107	
Push Bar								
 RM2612	RM2612	Up to 36" CTC	1 1/4"	676	729	691	535	600

\*Santoprene™ is a registered trademark of the Exxon Mobil Corporation.

### NeoMetrix - with GripZone

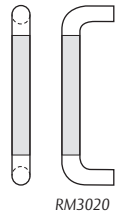

Straight Pulls						
Part	CTC	Dia.	3/605	9/611	32/629	32316
<b>RM3010</b>	12"	1"	386	435	229	363
	24"	1"	476	537	279	440
	36"	1"	566	639	327	518
<b>RM3020</b>	12"	1 1/4"	422	476	242	384
	24"	1 1/4"	509	575	292	462
	36"	1 1/4"	597	675	340	538
<b>RM3030</b>	12"	1 1/2"	494	558	270	427
	24"	1 1/2"	577	651	322	510
	36"	1 1/2"	658	743	376	594

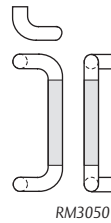

Offset Pulls						
Part	CTC	Dia.	3/605	9/611	32/629	32316
<b>RM3040</b>	12"	1"	430	485	266	419
	24"	1"	520	588	315	498
	36"	1"	611	690	363	575
<b>RM3050</b>	12"	1 1/4"	467	527	280	442
	24"	1 1/4"	553	625	329	519
	36"	1 1/4"	642	726	378	595
<b>RM3060</b>	12"	1 1/2"	540	610	307	486
	24"	1 1/2"	621	702	359	567
	36"	1 1/2"	703	795	413	652

NOTE: Post location on push bars can be located 1/8" from end for narrow & medium stile doors and 1" from end for flush and wide stile doors.

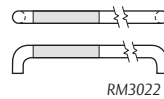

Push Bars - 7" Grip						
Part	CTC	Dia.	3/605	9/611	32/629	32316
<b>RM3012</b>	Up to 36"	1"	566	639	327	518
<b>RM3022</b>	Up to 36"	1 1/4"	597	675	340	538
<b>RM3032</b>	Up to 36"	1 1/2"	658	743	376	594

### Groove - Straight & Offset Pulls

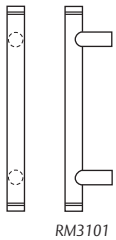

Straight Pulls - Flat Ends							
Part	Max OA	Dia.	3/605 4/606	10/612 10B/613	Stock PC 10BE	32D/630	32/629
<b>RM3101</b>	12"	1"	446	481	265	192	215
	24"	1"	494	533	348	236	265
	36"	1"	541	584	394	280	313
	48"	1"	588	635	440	323	362
	60"	1"	619	669	471	352	394
	72"	1"	651	702	501	381	426
	84"	1"	682	736	531	410	459
	96"	1"	713	770	561	438	491

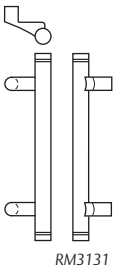

Offset Pulls - Flat Ends							
Part	Max OA	Dia.	3/605 4/606	10/612 10B/613	Stock PC 10BE	32D/630	32/629
<b>RM3131</b>	12"	1"	490	529	307	233	260
	24"	1"	537	580	390	277	310
	36"	1"	584	631	437	320	358
	48"	1"	632	683	482	363	408
	60"	1"	663	717	513	392	439
	72"	1"	694	750	543	421	471
	84"	1"	725	783	573	449	503
	96"	1"	757	816	628	478	536

MegaTek - Straight & Offset PostMount Pulls

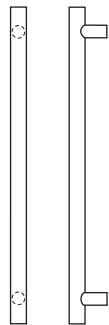

RM3300

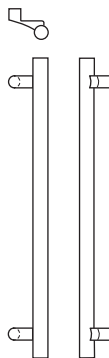

RM3311

Straight Pulls - Flat Ends (87" max overall in aluminum, specify CTC and overall length.)											
Part	Max OA	Dia.	28/628	313/710 315/711	3/605 4/606	10/612 10B/613	Stock PC 10BE	32D/630	32/629	32D316	32316
<b>RM3300</b>	12"	1"	143	158	370	400	208	142	160	203	227
	24"	1"	187	201	414	447	252	186	208	264	295
	36"	1"	231	247	459	497	332	228	255	323	361
	48"	1"	250	297	504	544	376	271	304	385	430
	60"	1"	280	326	533	576	406	300	334	423	475
	72"	1"	309	356	561	607	436	327	366	463	519
	84"	1"	339	386	590	639	464	354	398	503	564
	96"	1"			620	670	493	383	428	543	609
<b>RM3301</b>	12"	1 1/4"	163	180	387	418	222	155	175	221	248
	24"	1 1/4"	209	225	431	466	265	198	222	281	314
	36"	1 1/4"	252	269	475	514	346	241	270	342	383
	48"	1 1/4"	297	344	519	561	388	283	315	400	448
	60"	1 1/4"	326	374	549	593	418	310	347	439	492
	72"	1 1/4"	356	404	578	624	446	338	379	480	536
	84"	1 1/4"	386	432	607	656	476	366	410	519	582
	96"	1 1/4"			636	688	506	395	441	559	625
<b>RM3302</b>	12"	1 1/2"	189	256	403	436	235	170	190	239	269
	24"	1 1/2"	232	301	447	484	280	212	237	301	336
	36"	1 1/2"	278	345	491	532	359	253	285	360	403
	48"	1 1/2"	354	390	535	579	401	294	330	418	469
	60"	1 1/2"	383	420	565	611	430	323	361	456	512
	72"	1 1/2"	412	448	594	642	460	350	394	497	557
	84"	1 1/2"	442	478	623	674	489	379	424	536	601
	96"	1 1/2"			652	706	517	406	456	575	646
Offset Pulls - Flat Ends (Specify CTC and overall length.)											
<b>RM3310</b>	12"	1"	177	192	411	444	241	175	196	238	263
	24"	1"	220	235	456	492	285	217	243	299	331
	36"	1"	265	281	500	540	365	260	291	359	396
	48"	1"	282	328	544	587	407	301	335	418	462
	60"	1"	312	358	573	619	437	328	367	456	508
	72"	1"	341	388	603	650	465	356	399	497	552
	84"	1"	371	416	631	682	494	384	429	536	597
	96"	1"			660	713	525	413	461	575	641
<b>RM3311</b>	12"	1 1/4"	197	214	427	460	254	189	211	256	283
	24"	1 1/4"	243	259	471	508	334	230	258	316	348
	36"	1 1/4"	286	304	515	555	378	273	306	376	418
	48"	1 1/4"	328	376	559	604	420	312	349	433	481
	60"	1 1/4"	358	406	588	635	448	340	381	473	525
	72"	1 1/4"	388	435	618	666	479	368	413	512	569
	84"	1 1/4"	416	464	647	697	508	397	443	552	614
	96"	1 1/4"			676	729	536	424	474	592	658
<b>RM3312</b>	12"	1 1/2"	222	290	443	478	268	200	224	275	304
	24"	1 1/2"	266	335	487	526	348	243	272	335	372
	36"	1 1/2"	312	379	531	573	392	286	320	395	438
	48"	1 1/2"	386	422	575	622	431	324	362	450	501
	60"	1 1/2"	414	450	604	653	461	351	395	489	545
	72"	1 1/2"	444	480	634	684	490	380	425	529	589
	84"	1 1/2"	474	510	663	715	518	407	457	569	634
	96"	1 1/2"			692	747	549	436	488	610	678

- Add \$6.50/in. over 96".
- MP (Mid Post) - Add \$76 each (Recommended for maximum rigidity on long door pulls. See page 5 for guidelines.)

**ASSA ABLOY**

Experience a safer  
and more open world

MegaTek - Straight & Offset PostMount Pulls (con't)

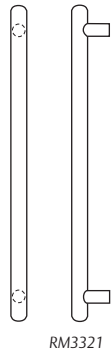

RM3321

Straight Pulls - Round Ends (90" max overall in aluminum, specify CTC and overall length.)											
Part	Max OA	Dia.	28/628	313/710 315/711	3/605 4/606	10/612 10B/613	Stock PC 10BE	32D/630	32/629	32D316	32316
<b>RM3320</b>	12"	1"	180	195	459	497	248	181	203	257	286
	24"	1"	225	240	504	544	328	224	250	317	356
	36"	1"	269	284	548	591	372	267	300	376	423
	48"	1"	289	337	591	640	413	306	342	433	485
	60"	1"	318	366	621	671	442	333	375	473	529
	72"	1"	348	395	650	702	471	361	405	512	574
	84"	1"	377	424	679	734	501	390	437	552	618
	96"	1"			708	765	530	418	467	592	662
<b>RM3321</b>	12"	1 1/4"	203	218	475	514	262	195	218	276	310
	24"	1 1/4"	249	263	519	561	341	237	265	336	375
	36"	1 1/4"	294	308	563	610	386	281	313	396	445
	48"	1 1/4"	337	384	608	657	425	318	356	450	505
	60"	1 1/4"	366	413	638	689	455	346	388	490	549
	72"	1 1/4"	395	443	666	720	484	375	419	529	593
	84"	1 1/4"	424	473	695	752	513	402	449	570	639
	96"	1 1/4"			725	783	542	429	482	610	682
<b>RM3322</b>	12"	1 1/2"	226	243	491	532	288	220	247	312	349
	24"	1 1/2"	271	286	535	579	369	263	294	373	418
	36"	1 1/2"	315	332	579	628	413	306	342	433	485
	48"	1 1/2"	354	390	624	675	449	341	383	484	543
	60"	1 1/2"	383	420	654	707	480	369	415	524	587
	72"	1 1/2"	412	448	682	738	509	398	445	564	630
	84"	1 1/2"	442	478	711	770	537	425	477	602	676
	96"	1 1/2"			741	801	591	453	509	643	720

Offset Pulls - Round Ends (Specify CTC and overall length.)											
<b>RM3330</b>	12"	1"	213	228	498	537	282	214	239	291	320
	24"	1"	257	273	542	585	361	256	287	350	390
	36"	1"	302	317	586	632	406	300	334	411	458
	48"	1"	320	367	630	681	444	335	377	464	518
	60"	1"	349	396	659	712	473	363	407	505	561
	72"	1"	378	426	689	743	504	392	439	544	608
	84"	1"	408	455	718	775	532	420	469	584	650
	96"	1"			747	806	584	447	502	624	694
<b>RM3331</b>	12"	1 1/4"	237	251	514	554	330	226	252	310	344
	24"	1 1/4"	282	296	558	603	374	269	302	371	410
	36"	1 1/4"	326	341	603	650	419	311	348	431	478
	48"	1 1/4"	367	414	647	697	457	347	389	482	536
	60"	1 1/4"	396	444	676	729	485	376	420	523	582
	72"	1 1/4"	426	474	705	761	514	403	450	561	625
	84"	1 1/4"	455	503	734	793	544	430	483	601	671
	96"	1 1/4"			763	824	597	459	514	641	714
<b>RM3332</b>	12"	1 1/2"	259	275	530	572	357	252	284	346	385
	24"	1 1/2"	304	320	574	621	402	295	331	407	451
	36"	1 1/2"	348	364	619	668	446	338	379	468	520
	48"	1 1/2"	384	421	663	715	481	370	416	515	574
	60"	1 1/2"	413	449	692	747	510	399	446	556	618
	72"	1 1/2"	443	479	721	779	538	426	478	596	662
	84"	1 1/2"	473	509	750	811	593	455	510	634	707
	96"	1 1/2"			779	842	621	483	540	675	752

- Add \$6.50/in. over 96".
- MP (Mid Post) - Add \$76 each (Recommended for maximum rigidity on long door pulls. See page 5 for guidelines.)

**ASSA ABLOY**

Experience a safer  
and more open world

MegaTek - Straight & Offset PostMount Pulls (con't)

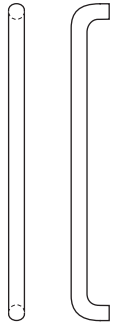

RM3341

Straight Pulls - Bent Ends (86" max CTC in aluminum, specify CTC.)											
Part	CTC	Dia.	28/628	313/710 315/711	3/605 4/606	10/612 10B/613	Stock PC 10BE	32D/630	32/629	32D316	32316
RM3340	12"	1"	135	149	308	333	195	131	147	186	207
	24"	1"	170	189	353	381	240	174	195	246	276
	36"	1"	207	227	398	429	284	216	242	306	343
	48"	1"	242	265	441	476	364	258	290	366	411
	60"	1"	277	305	481	519	383	276	310	392	439
	72"	1"	312	343	519	561	401	294	330	418	469
	84"	1"	346	381	614	663	439	330	369	468	524
	96"	1"			708	765	475	364	408	518	580
RM3341	12"	1 1/4"	147	162	370	400	208	142	160	203	227
	24"	1 1/4"	182	200	414	447	252	186	208	264	295
	36"	1 1/4"	217	240	459	497	332	228	255	323	361
	48"	1 1/4"	252	279	504	544	376	271	304	385	430
	60"	1 1/4"	288	317	543	586	395	289	323	408	456
	72"	1 1/4"	323	356	583	629	413	306	342	433	485
	84"	1 1/4"	358	395	685	740	449	341	382	483	540
	96"	1 1/4"			788	850	487	377	421	534	597
RM3342	12"	1 1/2"	164	181	449	485	245	178	199	253	282
	24"	1 1/2"	199	219	494	534	288	220	247	312	349
	36"	1 1/2"	234	259	538	581	369	263	294	373	418
	48"	1 1/2"	271	297	583	629	413	306	342	433	485
	60"	1 1/2"	306	337	623	672	425	318	356	450	505
	72"	1 1/2"	341	375	663	717	438	329	368	467	523
	84"	1 1/2"	376	413	758	816	475	364	408	515	580
	96"	1 1/2"			850	918	511	400	447	566	634

Push Bars - Flat Ends											
RM3102	Up to 36" CTC	1"	231	247	459	497	332	228	255	323	361
RM3112	Up to 36" CTC	1 1/4"	252	269	475	514	346	241	270	342	383
RM3122	Up to 36" CTC	1 1/2"	278	345	491	532	359	253	285	360	403
Push Bars - Round Ends											
RM3106	Up to 36" CTC	1"	269	284	548	591	372	267	300	376	423
RM3116	Up to 36" CTC	1 1/4"	294	308	563	610	386	281	313	396	445
RM3126	Up to 36" CTC	1 1/2"	315	332	619	668	413	306	342	433	485

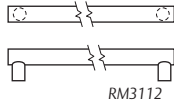

RM3112

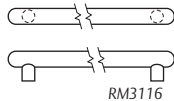

RM3116

- Add \$6.50/in. over 96".
- Add \$6.50/in. over 36" on Push Bars.
- MP (Mid Post) - Add \$76 each (Recommended for maximum rigidity on long door pulls. See page 5 for guidelines.)

NOTE: Post location on push bars can be located 1/8" from end for narrow & medium stile doors and 1" from end for flush and wide stile doors.

Quick Ship MegaTek - Straight PostMount Pulls

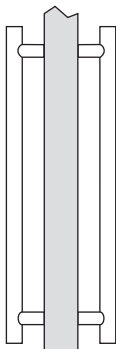

RM3301BTB

Straight Pulls - Flat Ends - Back-to-Back Mounting				
Part	CTC	OA	Dia.	32D/630
RM3301BTB1224.32D	12"	24"	1 1/4"	420
RM3301BTB2436.32D	24"	36"	1 1/4"	505
RM3301BTB3648.32D	36"	48"	1 1/4"	589
RM3301BTB4860.32D	48"	60"	1 1/4"	644
RM3301BTB6072.32D	60"	72"	1 1/4"	701
RM3301BTB7284.32D	72"	84"	1 1/4"	755
RM3301BTB8496.32D	84"	96"	1 1/4"	812

- Mounting included for both 1 3/4" wood or metal doors and 1/2" glass doors.

**ASSA ABLOY**

Experience a safer  
and more open world

NeoMax - Post Mounted GripZone

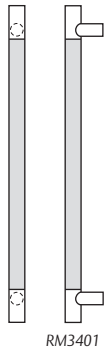

RM3401

Straight Pulls - Flat Ends						
Part	Max OA	Dia.	3/605	9/611	32/629	32316
<b>RM3400</b>	12"	1"	349	393	196	272
	24"	1"	439	496	244	339
	36"	1"	529	598	293	408
	48"	1"	619	700	342	475
	60"	1"	710	801	391	544
	72"	1"	800	903	440	612
	84"	1"	889	1,007	489	679
	96"	1"	981	1,108	538	748
<b>RM3401</b>	12"	1 1/4"	386	436	209	331
	24"	1 1/4"	472	534	258	408
	36"	1 1/4"	560	632	307	475
	48"	1 1/4"	648	731	356	562
	60"	1 1/4"	736	831	405	639
	72"	1 1/4"	823	930	453	717
	84"	1 1/4"	911	1,028	502	794
	96"	1 1/4"	997	1,128	551	870
<b>RM3402</b>	12"	1 1/2"	458	516	236	328
	24"	1 1/2"	540	610	289	400
	36"	1 1/2"	621	702	342	485
	48"	1 1/2"	703	796	394	549
	60"	1 1/2"	787	887	447	623
	72"	1 1/2"	868	981	500	694
	84"	1 1/2"	950	1,073	553	769
	96"	1 1/2"	1,031	1,166	605	841
Offset Pulls - Flat Ends						
<b>RM3410</b>	12"	1"	393	445	232	322
	24"	1"	483	547	281	389
	36"	1"	573	649	330	458
	48"	1"	665	752	379	526
	60"	1"	756	852	427	594
	72"	1"	846	955	476	662
	84"	1"	936	1,058	525	730
	96"	1"	1,026	1,160	573	797
<b>RM3411</b>	12"	1 1/4"	430	487	245	341
	24"	1 1/4"	517	585	294	409
	36"	1 1/4"	606	684	343	476
	48"	1 1/4"	692	783	392	545
	60"	1 1/4"	780	881	441	613
	72"	1 1/4"	868	981	490	681
	84"	1 1/4"	956	1,080	539	749
	96"	1 1/4"	1,043	1,179	588	816
<b>RM3412</b>	12"	1 1/2"	502	568	274	379
	24"	1 1/2"	585	660	324	452
	36"	1 1/2"	667	754	379	526
	48"	1 1/2"	749	846	431	599
	60"	1 1/2"	831	939	485	673
	72"	1 1/2"	913	1,031	536	746
	84"	1 1/2"	995	1,126	590	819
	96"	1 1/2"	1,078	1,217	642	892

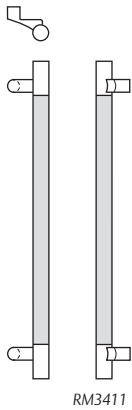

RM3411

- Add \$6.50/in. over 96".
- MP (Mid Post) - Add \$76 each (Recommended for maximum rigidity on long door pulls. See page 5 for guidelines.)

**ASSA ABLOY**

Experience a safer  
and more open world

NeoMax - Post Mounted GripZone (con't)

Straight Pulls - Round Ends						
Part	Max OA	Dia.	3/605	9/611	32/629	32316
<b>RM3420</b>	12"	1"	446	504	234	326
	24"	1"	537	607	283	394
	36"	1"	626	708	332	462
	48"	1"	718	810	381	530
	60"	1"	808	913	430	596
	72"	1"	899	1,015	478	664
	84"	1"	988	1,117	527	733
	96"	1"	1,079	1,218	575	801
	<b>RM3421</b>	12"	1 ¼"	482	546	248
24"		1 ¼"	570	646	296	412
36"		1 ¼"	658	743	345	480
48"		1 ¼"	745	842	394	549
60"		1 ¼"	833	941	443	616
72"		1 ¼"	920	1,041	492	685
84"		1 ¼"	1,009	1,140	541	751
96"		1 ¼"	1,096	1,238	590	819
<b>RM3422</b>		12"	1 ½"	555	628	276
	24"	1 ½"	638	721	327	454
	36"	1 ½"	720	812	381	530
	48"	1 ½"	801	906	433	602
	60"	1 ½"	883	999	487	675
	72"	1 ½"	967	1,091	539	749
	84"	1 ½"	1,048	1,185	592	824
	96"	1 ½"	1,130	1,277	644	895
	Offset Pulls - Round Ends					
<b>RM3430</b>	12"	1"	492	555	270	377
	24"	1"	582	657	319	444
	36"	1"	671	760	368	510
	48"	1"	762	862	417	580
	60"	1"	852	962	465	647
	72"	1"	943	1,066	515	716
	84"	1"	1,032	1,168	563	783
	96"	1"	1,125	1,270	613	852
	<b>RM3431</b>	12"	1 ¼"	530	598	284
24"		1 ¼"	617	697	333	463
36"		1 ¼"	705	797	382	531
48"		1 ¼"	792	896	431	599
60"		1 ¼"	880	994	479	666
72"		1 ¼"	968	1,093	528	734
84"		1 ¼"	1,056	1,191	576	803
96"		1 ¼"	1,142	1,290	626	870
<b>RM3432</b>		12"	1 ½"	601	679	311
	24"	1 ½"	683	771	363	505
	36"	1 ½"	765	865	417	580
	48"	1 ½"	847	957	469	652
	60"	1 ½"	930	1,050	522	727
	72"	1 ½"	1,011	1,142	574	800
	84"	1 ½"	1,093	1,236	628	873
	96"	1 ½"	1,176	1,329	680	946

- Add \$6.50/in. over 96".
- MP (Mid Post) - Add \$76 each (Recommended for maximum rigidity on long door pulls. See page 5 for guidelines.)

**ASSA ABLOY**

Experience a safer  
and more open world



NeoMax - Post Mounted GripZone (con't)

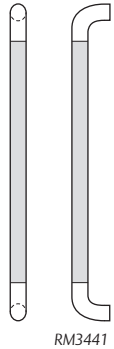

RM3441

Straight Pulls - Bent Ends (Specify CTC.)						
Part	CTC	Dia.	3/605	9/611	32/629	32316
<b>RM3440</b>	12"	1"	386	436	229	319
	24"	1"	476	537	279	387
	36"	1"	566	639	327	454
	48"	1"	656	741	376	522
	60"	1"	747	843	424	591
	72"	1"	837	946	474	659
	84"	1"	926	1,048	522	727
<b>RM3441</b>	96"	1"	1,018	1,150	571	795
	12"	1 1/4"	422	477	242	384
	24"	1 1/4"	509	576	292	462
	36"	1 1/4"	597	674	340	538
	48"	1 1/4"	684	773	390	615
	60"	1 1/4"	772	872	438	693
	72"	1 1/4"	860	971	488	770
<b>RM3442</b>	84"	1 1/4"	948	1,070	536	846
	96"	1 1/4"	1,035	1,169	586	924
	12"	1 1/2"	494	558	270	377
	24"	1 1/2"	577	651	322	448
	36"	1 1/2"	658	743	376	522
	48"	1 1/2"	740	837	428	595
	60"	1 1/2"	823	930	483	670
	72"	1 1/2"	905	1,022	534	743
	84"	1 1/2"	987	1,116	588	816
	96"	1 1/2"	1,068	1,207	640	889

Push Bars - Flat Ends (7" Grip)

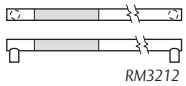

RM3212

Part	CTC	Dia.	3/605	9/611	32/629	32316
<b>RM3202</b>	Up to 36"	1"	529	598	293	408
<b>RM3212</b>	Up to 36"	1 1/4"	560	632	307	475
<b>RM3222</b>	Up to 36"	1 1/2"	621	702	342	485

Push Bars - Round Ends (7" Grip)

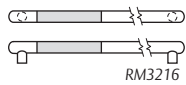

RM3216

<b>RM3206</b>	Up to 36"	1"	626	708	332	462
<b>RM3216</b>	Up to 36"	1 1/4"	658	743	345	480
<b>RM3226</b>	Up to 36"	1 1/2"	720	812	381	529

LineaMax - Grooved Pulls

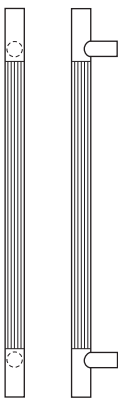

RM3701

Straight Pulls - Solid Flat Ends							
Part	Max OA	Dia.	3/605 4/606	10/612 10B/613	Stock PC 10BE	32D/630	32/629
<b>RM3701</b>	12"	1 1/4"	748	808	520	400	448
	24"	1 1/4"	898	969	639	489	547
	36"	1 1/4"	1,047	1,130	732	576	646
	48"	1 1/4"	1,197	1,291	826	665	745
	60"	1 1/4"	1,346	1,453	919	753	843
	72"	1 1/4"	1,495	1,614	1,014	841	943
	84"	1 1/4"	1,644	1,777	1,131	930	1,042
<b>RM3702</b>	96"	1 1/4"	1,794	1,938	1,225	1,019	1,141
	12"	1 1/2"	901	973	566	442	496
	24"	1 1/2"	1,062	1,148	692	539	604
	36"	1 1/2"	1,225	1,323	795	635	711
	48"	1 1/2"	1,386	1,498	897	732	820
	60"	1 1/2"	1,550	1,673	999	828	928
	72"	1 1/2"	1,711	1,848	1,126	925	1,036
	84"	1 1/2"	1,872	2,024	1,227	1,021	1,143
	96"	1 1/2"	2,035	2,197	1,329	1,117	1,251

- Add \$8.10/in. over 96".
- MP (Mid Post) - Add \$68 each (Recommended for maximum rigidity on long door pulls. See page 5 for guidelines).

**ASSA ABLOY**

Experience a safer  
and more open world

LineaMax - Grooved Pulls (con't)

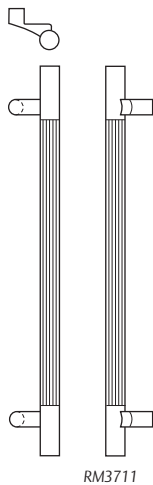

RM3711

Offset Pulls - Solid Flat Ends							
Part	Max OA	Dia.	3/605 4/606	10/612 10B/613	Stock PC 10BE	32D/630	32/629
<b>RM3711</b>	12"	1 1/4"	792	854	564	440	494
	24"	1 1/4"	941	1,017	682	528	593
	36"	1 1/4"	1,091	1,177	776	617	692
	48"	1 1/4"	1,240	1,339	869	705	790
	60"	1 1/4"	1,389	1,500	962	795	888
	72"	1 1/4"	1,538	1,662	1,056	882	987
	84"	1 1/4"	1,688	1,823	1,174	970	1,087
<b>RM3712</b>	12"	1 1/2"	944	1,020	633	484	541
	24"	1 1/2"	1,106	1,195	736	579	649
	36"	1 1/2"	1,269	1,371	837	675	756
	48"	1 1/2"	1,430	1,544	939	772	864
	60"	1 1/2"	1,593	1,719	1,042	867	972
	72"	1 1/2"	1,754	1,894	1,167	964	1,080
	84"	1 1/2"	1,916	2,070	1,270	1,061	1,188
	96"	1 1/2"	2,079	2,245	1,373	1,158	1,296

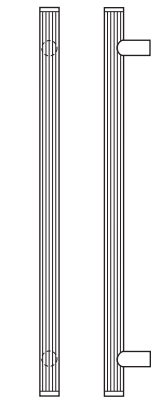

RM3721

Straight Pulls - Fully Grooved Flat Ends							
<b>RM3721</b>	12"	1 1/4"	537	580	408	294	329
	24"	1 1/4"	678	732	497	378	422
	36"	1 1/4"	819	884	610	461	517
	48"	1 1/4"	959	1,036	699	545	610
	60"	1 1/4"	1,100	1,188	787	628	704
	72"	1 1/4"	1,241	1,341	876	712	798
	84"	1 1/4"	1,382	1,492	965	797	891
<b>RM3722</b>	12"	1 1/2"	585	632	452	335	375
	24"	1 1/2"	732	792	547	424	475
	36"	1 1/2"	880	950	666	514	575
	48"	1 1/2"	1,026	1,109	760	603	675
	60"	1 1/2"	1,173	1,268	855	693	776
	72"	1 1/2"	1,321	1,426	951	782	876
	84"	1 1/2"	1,467	1,586	1,045	872	976
	96"	1 1/2"	1,614	1,744	1,164	961	1,076

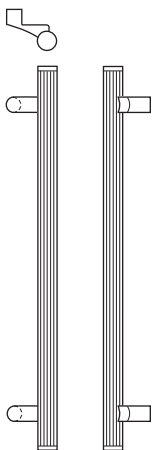

RM3731

Offset Pulls - Fully Grooved Flat Ends							
<b>RM3731</b>	12"	1 1/4"	581	626	451	334	374
	24"	1 1/4"	722	779	540	417	467
	36"	1 1/4"	863	932	652	501	561
	48"	1 1/4"	1,004	1,083	741	586	655
	60"	1 1/4"	1,144	1,235	830	669	749
	72"	1 1/4"	1,285	1,388	918	752	842
	84"	1 1/4"	1,426	1,539	1,007	836	936
<b>RM3732</b>	12"	1 1/2"	629	679	494	375	420
	24"	1 1/2"	776	838	614	464	520
	36"	1 1/2"	923	996	709	553	621
	48"	1 1/2"	1,070	1,156	803	643	721
	60"	1 1/2"	1,217	1,314	898	733	821
	72"	1 1/2"	1,365	1,474	993	823	921
	84"	1 1/2"	1,512	1,632	1,088	912	1,021
	96"	1 1/2"	1,659	1,791	1,206	1,002	1,122

- Add \$8.10/in. over 96".
- MP (Mid Post) - Add \$68 each (Recommended for maximum rigidity on long door pulls. See page 5 for guidelines).

**ASSA ABLOY**

Experience a safer  
and more open world

LineaMax - Grooved Pulls (con't)

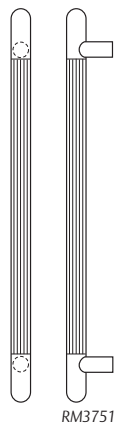
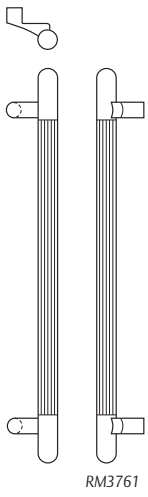
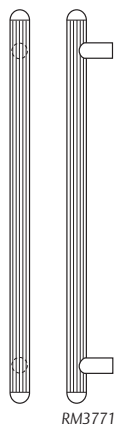
Straight Pulls - Solid Round Ends							
Part	Max OA	Dia.	3/605 4/606	10/612 10B/613	Stock PC 10BE	32D/630	32/629
 RM3751	12"	1 1/4"	847	915	582	458	513
	24"	1 1/4"	996	1,077	700	546	612
	36"	1 1/4"	1,147	1,238	794	634	710
	48"	1 1/4"	1,296	1,399	887	723	809
	60"	1 1/4"	1,446	1,561	981	811	909
	72"	1 1/4"	1,595	1,723	1,074	900	1,008
	84"	1 1/4"	1,745	1,885	1,193	987	1,107
	96"	1 1/4"	1,894	2,045	1,286	1,075	1,204
	RM3752	12"	1 1/2"	1,000	1,081	651	500
24"		1 1/2"	1,163	1,256	754	597	668
36"		1 1/2"	1,324	1,430	855	693	776
48"		1 1/2"	1,486	1,605	957	789	883
60"		1 1/2"	1,648	1,781	1,060	885	991
72"		1 1/2"	1,810	1,956	1,186	982	1,099
84"		1 1/2"	1,973	2,131	1,288	1,077	1,206
	96"	1 1/2"	2,135	2,304	1,390	1,174	1,316
Offset Pulls - Solid Round Ends							
 RM3761	12"	1 1/4"	890	961	649	498	557
	24"	1 1/4"	1,041	1,124	742	587	656
	36"	1 1/4"	1,190	1,285	836	674	755
	48"	1 1/4"	1,340	1,447	930	762	854
	60"	1 1/4"	1,489	1,608	1,023	851	953
	72"	1 1/4"	1,639	1,770	1,141	939	1,051
	84"	1 1/4"	1,788	1,931	1,234	1,028	1,151
	96"	1 1/4"	1,938	2,094	1,328	1,116	1,250
	RM3762	12"	1 1/2"	1,044	1,128	693	540
24"		1 1/2"	1,206	1,303	796	636	713
36"		1 1/2"	1,368	1,478	898	733	821
48"		1 1/2"	1,530	1,653	1,001	829	929
60"		1 1/2"	1,693	1,827	1,127	926	1,037
72"		1 1/2"	1,854	2,002	1,229	1,022	1,145
84"		1 1/2"	2,016	2,177	1,331	1,119	1,252
	96"	1 1/2"	2,178	2,352	1,432	1,215	1,360
Straight Pulls - Fully Grooved Round Ends							
 RM3771	12"	1 1/4"	636	688	469	350	393
	24"	1 1/4"	777	840	558	435	487
	36"	1 1/4"	918	991	671	518	581
	48"	1 1/4"	1,059	1,144	759	602	674
	60"	1 1/4"	1,200	1,296	848	686	768
	72"	1 1/4"	1,341	1,448	937	770	862
	84"	1 1/4"	1,482	1,600	1,025	853	956
	96"	1 1/4"	1,623	1,752	1,138	937	1,049
	RM3772	12"	1 1/2"	686	740	513	392
24"		1 1/2"	832	899	632	483	540
36"		1 1/2"	979	1,058	727	571	640
48"		1 1/2"	1,127	1,216	822	660	739
60"		1 1/2"	1,273	1,376	916	750	840
72"		1 1/2"	1,420	1,534	1,010	839	940
84"		1 1/2"	1,568	1,694	1,130	929	1,040
	96"	1 1/2"	1,714	1,852	1,225	1,019	1,141

- Add \$8.10/in. over 96".
- MP (Mid Post) - Add \$68 each (Recommended for maximum rigidity on long door pulls. See page 5 for guidelines).

**ASSA ABLOY**

Experience a safer  
and more open world

LineaMax - Grooved Pulls (con't)

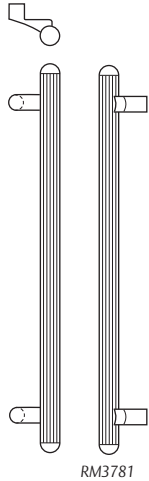

Offset Pulls - Fully Grooved Round Ends							
Part	Max OA	Dia.	3/605 4/606	10/612 10B/613	Stock PC 10BE	32D/630	32/629
<b>RM3781</b>	12"	1 1/4"	681	735	512	391	438
	24"	1 1/4"	822	886	624	475	531
	36"	1 1/4"	961	1,040	713	558	626
	48"	1 1/4"	1,102	1,191	802	642	720
	60"	1 1/4"	1,243	1,343	890	726	813
	72"	1 1/4"	1,384	1,495	979	810	907
	84"	1 1/4"	1,525	1,647	1,068	894	1,002
	96"	1 1/4"	1,666	1,799	1,181	977	1,094
<b>RM3782</b>	12"	1 1/2"	729	788	555	433	485
	24"	1 1/2"	876	946	674	522	584
	36"	1 1/2"	1,023	1,105	770	612	685
	48"	1 1/2"	1,170	1,264	864	701	784
	60"	1 1/2"	1,317	1,423	958	790	885
	72"	1 1/2"	1,464	1,580	1,054	879	985
	84"	1 1/2"	1,611	1,741	1,173	969	1,085
	96"	1 1/2"	1,757	1,898	1,268	1,059	1,186

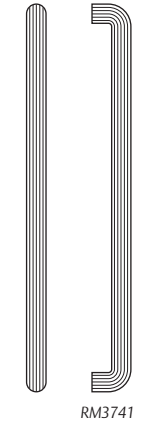

Straight Pulls - Fully Grooved Bent Ends							
Part	Max OA	Dia.	3/605 4/606	10/612 10B/613	Stock PC 10BE	32D/630	32/629
<b>RM3741</b>	12"	1 1/4"				328	368
	24"	1 1/4"				412	461
	36"	1 1/4"				496	554
	48"	1 1/4"				579	649
	60"	1 1/4"				662	743
	72"	1 1/4"				747	836
	84"	1 1/4"				830	930
	96"	1 1/4"				914	1,024
<b>RM3742</b>	12"	1 1/2"				370	414
	24"	1 1/2"				459	514
	36"	1 1/2"				548	615
	48"	1 1/2"				638	714
	60"	1 1/2"				727	814
	72"	1 1/2"				816	915
	84"	1 1/2"				907	1,015
	96"	1 1/2"				995	1,115

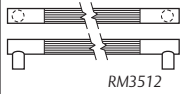

Push Bars Solid Grooves Flat Ends							
Part	Max OA	Dia.	3/605 4/606	10/612 10B/613	Stock PC 10BE	32D/630	32/629
<b>RM3512</b>	Up to 36" CTC	1 1/4"	1,047	1,130	732	576	646
<b>RM3522</b>	Up to 36" CTC	1 1/2"	1,225	1,323	795	635	711

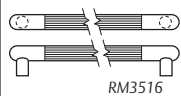

Push Bars Solid Grooves Round Ends							
Part	Max OA	Dia.	3/605 4/606	10/612 10B/613	Stock PC 10BE	32D/630	32/629
<b>RM3516</b>	Up to 36" CTC	1 1/4"	1,147	1,238	794	634	710
<b>RM3526</b>	Up to 36" CTC	1 1/2"	1,324	1,430	855	693	776

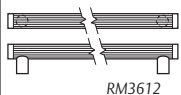

Push Bars Fully Grooved - Flat Ends							
Part	Max OA	Dia.	3/605 4/606	10/612 10B/613	Stock PC 10BE	32D/630	32/629
<b>RM3612</b>	Up to 36" CTC	1 1/4"	819	884	610	461	517
<b>RM3622</b>	Up to 36" CTC	1 1/2"	880	950	666	514	575

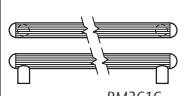

Push Bars Fully Grooved - Round Ends							
Part	Max OA	Dia.	3/605 4/606	10/612 10B/613	Stock PC 10BE	32D/630	32/629
<b>RM3616</b>	Up to 36" CTC	1 1/4"	918	991	671	518	581
<b>RM3626</b>	Up to 36" CTC	1 1/2"	979	1,058	727	571	640

- Add \$8.10/in. over 96".
- MP (Mid Post) - Add \$68 each (Recommended for maximum rigidity on long door pulls. See page 5 for guidelines).

**ASSA ABLOY**

Experience a safer  
and more open world

## NoirMet - Black Anodized Grip with Contrasting Ends and Posts



RM3810

Straight Pulls - Flat Ends									
Part	Max OA	Dia.	3/605 4/606	10/612 10B/613	Stock PC 10BE	32D/630	32/629	32D316	32316
<b>RM3800</b>	12"	1"	374	432	376	271	299	385	423
	24"	1"	408	464	403	298	328	422	463
	36"	1"	422	478	419	314	345	443	487
	48"	1"	628	686	517	410	452	580	639
	60"	1"	683	729	541	434	477	613	675
	72"	1"	735	773	563	456	501	644	710
	84"	1"	840	887	619	485	534	688	755
	96"	1"	944	1,002	649	515	566	728	801
<b>RM3810</b>	12"	1 1/4"	394	449	384	280	306	396	435
	24"	1 1/4"	449	485	419	314	345	443	487
	36"	1 1/4"	467	505	435	329	361	464	511
	48"	1 1/4"	629	686	535	428	470	605	665
	60"	1 1/4"	664	712	552	444	489	629	692
	72"	1 1/4"	699	737	570	462	508	653	717
	84"	1 1/4"	831	868	651	517	570	731	806
	96"	1 1/4"	964	997	707	572	629	809	888
<b>RM3820</b>	12"	1 1/2"	488	524	435	329	361	464	511
	24"	1 1/2"	543	579	462	356	391	504	554
	36"	1 1/2"	589	626	499	393	432	556	611
	48"	1 1/2"	670	688	571	463	509	654	719
	60"	1 1/2"	731	752	630	497	547	702	773
	72"	1 1/2"	793	813	664	530	583	749	824
	84"	1 1/2"	908	929	720	585	644	828	910
	96"	1 1/2"	1,023	1,042	778	641	705	906	997
Offset Pulls - Flat Ends									
<b>RM3830</b>	12"	1"	422	524	419	314	345	443	487
	24"	1"	500	594	467	361	399	511	562
	36"	1"	590	671	517	410	452	580	639
	48"	1"	679	750	566	459	506	649	715
	60"	1"	734	794	591	482	531	681	750
	72"	1"	787	837	638	505	554	713	785
	84"	1"	893	952	682	547	602	773	850
	96"	1"	995	1,065	724	587	647	831	913
<b>RM3840</b>	12"	1 1/4"	440	543	426	321	353	453	498
	24"	1 1/4"	529	608	475	369	406	522	573
	36"	1 1/4"	605	679	525	417	458	590	647
	48"	1 1/4"	681	750	572	464	510	656	720
	60"	1 1/4"	716	776	590	481	530	680	749
	72"	1 1/4"	750	801	631	498	548	704	774
	84"	1 1/4"	882	933	688	553	610	784	863
	96"	1 1/4"	1,015	1,062	744	608	669	860	946
<b>RM3850</b>	12"	1 1/2"	533	618	477	371	409	525	579
	24"	1 1/2"	589	671	499	393	432	556	611
	36"	1 1/2"	656	713	554	446	493	631	697
	48"	1 1/2"	722	753	632	499	549	706	776
	60"	1 1/2"	784	815	668	533	586	754	829
	72"	1 1/2"	844	878	702	566	623	801	882
	84"	1 1/2"	959	991	758	622	684	880	967
	96"	1 1/2"	1,075	1,106	815	678	745	958	1,054

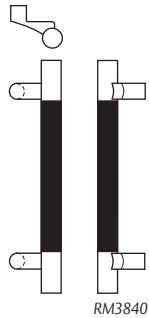

RM3840

• Add \$6.50/in. over 36".

NOTE: Post location on push bars can be located 1/8" from end for narrow & medium stile doors and 1" from end for flush and wide stile doors.

NoirMet - Black Anodized Grip with Contrasting Ends and Posts (con't)

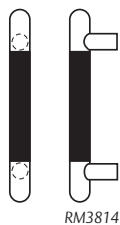

RM3804

Straight Pulls - Round Ends									
Part	Max OA	Dia.	3/605 4/606	10/612 10B/613	Stock PC 10BE	32D/630	32/629	32D316	32316
RM3804	12"	1"	422	478	419	314	345	443	487
	24"	1"	454	511	448	342	376	485	533
	36"	1"	467	524	462	356	391	504	554
	48"	1"	676	731	566	459	506	649	715
	60"	1"	728	776	591	482	531	681	750
	72"	1"	779	817	639	506	555	715	786
RM3814	84"	1"	884	932	683	548	603	774	851
	96"	1"	987	1,044	725	589	649	833	917
	12"	1 1/4"	440	497	426	321	353	453	498
	24"	1 1/4"	498	534	461	355	390	501	552
	36"	1 1/4"	516	551	477	371	409	525	579
	48"	1 1/4"	677	734	575	466	512	659	726
RM3824	60"	1 1/4"	712	758	593	483	532	682	752
	72"	1 1/4"	744	781	635	500	550	709	777
	84"	1 1/4"	876	914	691	555	613	786	865
	96"	1 1/4"	1,008	1,045	747	612	671	864	949
	12"	1 1/2"	533	571	477	371	409	525	579
	24"	1 1/2"	589	626	499	393	432	556	611
RM3834	36"	1 1/2"	634	671	543	436	479	617	679
	48"	1 1/2"	716	736	635	500	550	709	777
	60"	1 1/2"	777	798	669	534	587	755	831
	72"	1 1/2"	838	859	703	567	624	802	883
	84"	1 1/2"	952	972	757	620	683	877	966
	96"	1 1/2"	1,065	1,084	811	674	742	954	1,049

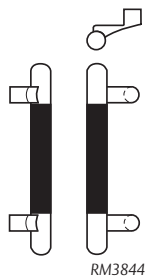

RM3844

Offset Pulls - Round Ends									
RM3834	12"	1"	467	505	462	356	391	504	554
	24"	1"	548	591	510	403	443	571	628
	36"	1"	638	690	558	449	495	635	699
	48"	1"	727	785	629	496	545	700	772
	60"	1"	779	842	652	518	571	734	808
	72"	1"	831	898	675	542	596	766	843
RM3844	84"	1"	936	1,010	719	584	642	826	909
	96"	1"	1,039	1,121	761	625	701	885	990
	12"	1 1/4"	488	526	467	361	406	511	573
	24"	1 1/4"	576	621	516	409	458	579	647
	36"	1 1/4"	652	705	564	457	511	646	723
	48"	1 1/4"	728	787	637	504	563	711	796
RM3854	60"	1 1/4"	763	824	653	519	582	735	823
	72"	1 1/4"	796	861	671	537	602	759	850
	84"	1 1/4"	929	1,003	728	593	664	838	940
	96"	1 1/4"	1,059	1,144	783	648	725	916	1,025
	12"	1 1/2"	579	625	518	411	462	582	653
	24"	1 1/2"	634	685	543	436	488	617	691
RM3854	36"	1 1/2"	701	758	620	487	545	689	772
	48"	1 1/2"	766	829	671	537	602	759	850
	60"	1 1/2"	829	896	706	571	639	808	904
	72"	1 1/2"	889	960	739	604	677	853	957
	84"	1 1/2"	1,004	1,083	795	658	737	931	1,042
	96"	1 1/2"	1,117	1,205	850	713	798	1,007	1,128



RM3812

Push Bars - Flat Ends									
RM3802	Up to 36" CTC	1"	422	478	419	314	345	443	487
RM3812	Up to 36" CTC	1 1/4"	467	505	435	329	361	464	511
RM3822	Up to 36" CTC	1 1/2"	589	626	499	393	432	556	611



RM3816

Push Bars - Round Ends									
RM3806	Up to 36" CTC	1"	467	524	462	356	391	504	554
RM3816	Up to 36" CTC	1 1/4"	516	551	477	371	409	525	579
RM3826	Up to 36" CTC	1 1/2"	634	671	543	436	479	617	679

• Add \$6.50/in. over 36".

NOTE: Post location on push bars can be located 1/8" from end for narrow & medium stile doors and 1" from end for flush and wide stile doors.

**ASSA ABLOY**

Experience a safer  
and more open world

## NoirTek - Black Anodized Grip with Contrasting Posts

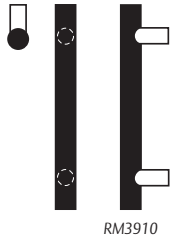

RM3910

Straight Pulls - Flat Ends									
Part	Max OA	Dia.	28/628	313/710 315/711	3/605 4/606	10/612 108/613	Stock PC 10BE	32D/630	32/629
<b>RM3900</b>	12"	1"	189	209	246	265	246	181	204
	24"	1"	268	294	280	301	272	207	231
	36"	1"	347	381	294	317	288	223	249
	48"	1"	426	469	499	540	425	320	358
	60"	1"	505	556	553	597	448	342	384
	72"	1"	585	642	606	654	471	365	408
	84"	1"	662	728	712	769	502	395	442
<b>RM3910</b>	12"	1 1/4"	208	228	265	286	253	188	211
	24"	1 1/4"	291	321	322	348	288	223	249
	36"	1 1/4"	376	413	338	366	305	239	266
	48"	1 1/4"	460	506	500	541	442	336	376
	60"	1 1/4"	543	597	535	578	460	354	396
	72"	1 1/4"	627	690	570	616	476	370	414
	84"	1 1/4"	712	783	702	759	533	426	477
<b>RM3920</b>	12"	1 1/2"	246	271	359	388	305	239	266
	24"	1 1/2"	314	346	413	447	369	265	297
	36"	1 1/2"	383	421	461	498	407	302	338
	48"	1 1/2"	452	497	542	585	477	371	416
	60"	1 1/2"	521	572	604	652	513	406	454
	72"	1 1/2"	589	649	664	718	547	439	492
	84"	1 1/2"	657	723	779	842	628	495	553

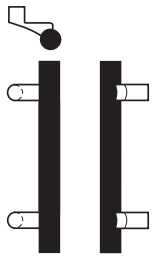

RM3940

Offset Pulls - Flat Ends									
<b>RM3930</b>	12"	1"			290	315	289	224	250
	24"	1"			324	351	353	249	279
	36"	1"			338	366	369	265	297
	48"	1"			544	587	467	361	405
	60"	1"			598	647	492	386	431
	72"	1"			651	703	514	407	456
	84"	1"			757	816	544	437	490
<b>RM3940</b>	12"	1 1/4"			311	335	297	230	259
	24"	1 1/4"			367	396	369	265	297
	36"	1 1/4"			384	413	385	281	315
	48"	1 1/4"			546	589	485	378	425
	60"	1 1/4"			580	626	504	396	443
	72"	1 1/4"			615	664	519	412	463
	84"	1 1/4"			748	807	577	469	525
<b>RM3950</b>	12"	1 1/2"			404	437	385	281	315
	24"	1 1/2"			460	496	412	306	343
	36"	1 1/2"			506	546	451	345	387
	48"	1 1/2"			586	633	520	413	464
	60"	1 1/2"			649	700	555	447	502
	72"	1 1/2"			708	765	590	481	538
	84"	1 1/2"			825	890	671	537	602

• Add \$6.50/in. over 36".

NOTE: Post location on push bars can be located 1/8" from end for narrow & medium stile doors and 1" from end for flush and wide stile doors.

NoirTek - Black Anodized Grip with Contrasting Posts (con't)



RM3914

Straight Pulls - Round Ends									
Part	Max OA	Dia.	28/628	313/710 315/711	3/605 4/606	10/612 10B/613	Stock PC 10BE	32D/630	32/629
<b>RM3904</b>	12"	1"	234	258	349	376	296	229	257
	24"	1"	310	341	383	412	359	255	286
	36"	1"	384	423	396	428	375	270	303
	48"	1"	460	506	602	651	474	368	412
	60"	1"	535	588	656	708	497	391	438
	72"	1"	609	670	708	765	519	412	463
	84"	1"	685	753	814	880	551	443	497
<b>RM3914</b>	12"	1 1/4"	252	278	368	398	304	237	265
	24"	1 1/4"	326	358	425	459	375	270	303
	36"	1 1/4"	400	440	441	476	392	287	321
	48"	1 1/4"	474	522	604	652	492	386	431
	60"	1 1/4"	547	602	638	689	509	402	449
	72"	1 1/4"	622	684	672	727	527	420	470
	84"	1 1/4"	695	765	806	870	583	475	532
<b>RM3924</b>	12"	1 1/2"	291	321	462	499	392	287	321
	24"	1 1/2"	372	409	517	559	419	314	351
	36"	1 1/2"	452	497	563	608	457	351	393
	48"	1 1/2"	533	586	644	696	528	421	471
	60"	1 1/2"	611	673	706	763	562	454	509
	72"	1 1/2"	692	761	766	828	620	487	546
	84"	1 1/2"	773	850	882	953	676	543	608

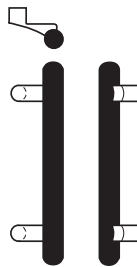

RM3944

Offset Pulls - Round Ends									
<b>RM3934</b>	12"	1"			394	425	376	271	304
	24"	1"			427	461	403	298	333
	36"	1"			441	476	419	314	351
	48"	1"			648	699	517	410	460
	60"	1"			701	758	541	434	485
	72"	1"			754	814	563	456	510
	84"	1"			860	929	619	485	544
<b>RM3944</b>	12"	1 1/4"			412	445	384	280	314
	24"	1 1/4"			470	507	419	314	351
	36"	1 1/4"			485	525	435	329	369
	48"	1 1/4"			649	700	535	428	479
	60"	1 1/4"			684	738	552	444	498
	72"	1 1/4"			719	775	570	462	516
	84"	1 1/4"			850	918	651	517	580
<b>RM3954</b>	12"	1 1/2"			507	547	435	329	369
	24"	1 1/2"			562	607	462	356	399
	36"	1 1/2"			608	657	499	393	441
	48"	1 1/2"			690	744	571	463	518
	60"	1 1/2"			752	811	630	497	557
	72"	1 1/2"			812	877	664	530	593
	84"	1 1/2"			929	1,003	720	585	656



RM3912

Push Bars - Flat Ends									
<b>RM3902</b>	Up to 36" CTC	1"	347	381	294	317	288	223	249
<b>RM3912</b>	Up to 36" CTC	1 1/4"	376	413	338	366	305	239	266
<b>RM3922</b>	Up to 36" CTC	1 1/2"	383	421	461	498	407	302	338



RM3916

Push Bars - Round Ends									
<b>RM3906</b>	Up to 36" CTC	1"	384	423	396	428	375	270	303
<b>RM3916</b>	Up to 36" CTC	1 1/4"	400	440	441	476	392	287	321
<b>RM3926</b>	Up to 36" CTC	1 1/2"	452	497	563	608	457	351	393

• Add \$6.50/in. over 36".

NOTE: Post location on push bars can be located 1/8" from end for narrow & medium stile doors and 1" from end for flush and wide stile doors.

**ASSA ABLOY**

Experience a safer  
and more open world



## ArborMet - Wood Grip Pulls

Straight Pulls - Flat Ends							
Part	Max OA	Dia.	3/605 4/606	10/612 10B/613	Stock PC 10BE	32D/630	32/629
<b>RM4000</b>	12"	1"	483	522	480	361	405
	24"	1"	546	589	541	419	468
	36"	1"	608	656	625	476	532
	48"	1"	670	724	687	534	598
<b>RM4010</b>	12"	1 ¼"	505	545	494	375	420
	24"	1 ¼"	567	613	555	433	485
	36"	1 ¼"	629	679	640	490	548
<b>RM4020</b>	12"	1 ½"	588	635	553	430	483
	24"	1 ½"	651	702	638	488	546
	36"	1 ½"	713	770	699	545	610
	48"	1 ½"	775	837	759	602	674
Offset Pulls - Flat Ends							
<b>RM4030</b>	12"	1"	527	569	522	401	449
	24"	1"	589	636	607	459	514
	36"	1"	652	704	668	516	578
	48"	1"	714	771	729	573	642
<b>RM4040</b>	12"	1 ¼"	548	591	537	415	465
	24"	1 ¼"	611	659	622	473	529
	36"	1 ¼"	672	727	684	529	594
<b>RM4050</b>	12"	1 ½"	632	683	620	470	526
	24"	1 ½"	694	750	681	527	591
	36"	1 ½"	757	816	741	586	655
	48"	1 ½"	819	884	802	642	720
Straight Pulls - Round Ends							
<b>RM4004</b>	12"	1"	583	630	529	408	456
	24"	1"	646	696	614	464	520
	36"	1"	707	764	674	522	584
	48"	1"	770	832	736	579	649
<b>RM4014</b>	12"	1 ¼"	605	653	543	421	471
	24"	1 ¼"	667	720	628	478	536
	36"	1 ¼"	729	788	689	536	600
<b>RM4024</b>	12"	1 ½"	688	742	625	476	532
	24"	1 ½"	750	810	687	534	598
	36"	1 ½"	812	878	747	591	661
	48"	1 ½"	875	944	808	648	726

• Add on will apply for Premium and Super Premium wood species, as well as any additional wood finishing. See page 39.

NOTE: Post location on push bars can be located 1/8" from end for narrow & medium stile doors and 1" from end for flush and wide stile doors.

## ArborMet - Wood Grip Pulls (con't)

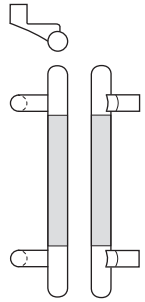

RM4034

Offset Pulls - Round Ends							
Part	Max OA	Dia.	3/605 4/606	10/612 10B/613	Stock PC 10BE	32D/630	32/629
<b>RM4034</b>	12"	1"	626	677	571	447	501
	24"	1"	689	744	657	504	565
	36"	1"	752	811	717	562	629
	48"	1"	813	879	778	620	694
<b>RM4044</b>	12"	1 ¼"	648	700	610	461	517
	24"	1 ¼"	711	767	671	518	581
	36"	1 ¼"	773	834	731	575	645
	48"	1 ¼"	835	902	793	633	709
<b>RM4054</b>	12"	1 ½"	731	791	668	516	578
	24"	1 ½"	794	858	729	573	642
	36"	1 ½"	856	924	791	630	707
	48"	1 ½"	918	991	850	688	771

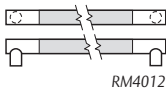

RM4012

Push Bars - Flat Ends							
<b>RM4002</b>	Up to 36" CTC	1"	608	656	625	476	532
<b>RM4012</b>	Up to 36" CTC	1 ¼"	629	679	640	490	548
<b>RM4022</b>	Up to 36" CTC	1 ½"	713	770	699	545	610

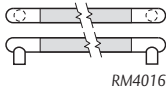

RM4016

Push Bars - Round Ends							
<b>RM4006</b>	Up to 36" CTC	1"	707	764	674	522	584
<b>RM4016</b>	Up to 36" CTC	1 ¼"	729	788	689	536	600
<b>RM4026</b>	Up to 36" CTC	1 ½"	812	878	747	591	661

- Add on will apply for Premium and Super Premium wood species, as well as any additional wood finishing. See page 39.

NOTE: Post location on push bars can be located 1/8" from end for narrow & medium stile doors and 1" from end for flush and wide stile doors.

ArborMet - Wood Grip Pulls (con't)

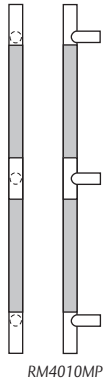

RM4010MP

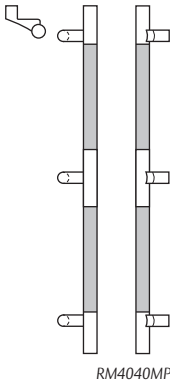

RM4040MP

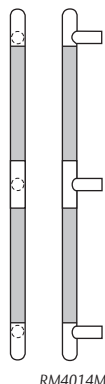

RM4014MP

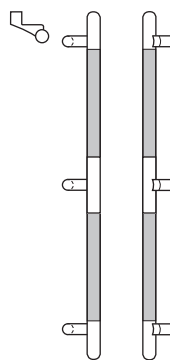

RM4044MP

Straight Pulls - Flat Ends							
Part	Max OA	Dia.	3/605 4/606	10/612 10B/613	Stock PC 10BE	32D/630	32/629
<b>RM4000MP</b>	60"	1"	779	842	798	639	716
	72"	1"	842	909	860	697	780
	84"	1"	904	976	920	754	844
	96"	1"	967	1,044	982	812	910
<b>RM4010MP</b>	60"	1 ¼"	800	865	813	652	730
	72"	1 ¼"	863	933	873	710	796
	84"	1 ¼"	924	999	935	768	859
	96"	1 ¼"	987	1,066	996	826	925
<b>RM4020MP</b>	60"	1 ½"	884	955	870	707	792
	72"	1 ½"	947	1,022	932	764	857
	84"	1 ½"	1,009	1,090	993	823	921
	96"	1 ½"	1,071	1,156	1,054	880	986
Offset Pulls - Flat Ends							
<b>RM4030MP</b>	60"	1"	824	888	841	678	759
	72"	1"	885	956	902	736	825
	84"	1"	948	1,023	962	795	889
	96"	1"	1,010	1,091	1,024	852	954
<b>RM4040MP</b>	60"	1 ¼"	844	912	854	693	775
	72"	1 ¼"	906	979	916	750	840
	84"	1 ¼"	969	1,046	977	808	905
	96"	1 ¼"	1,030	1,114	1,039	865	969
<b>RM4050MP</b>	60"	1 ½"	929	1,003	914	747	837
	72"	1 ½"	990	1,068	975	805	902
	84"	1 ½"	1,053	1,136	1,037	862	966
	96"	1 ½"	1,115	1,203	1,097	920	1,032
Straight Pulls - Round Ends							
<b>RM4004MP</b>	60"	1"	879	950	847	684	766
	72"	1"	941	1,017	908	742	831
	84"	1"	1,004	1,084	970	800	896
	96"	1"	1,065	1,151	1,030	857	960
<b>RM4014MP</b>	60"	1 ¼"	901	973	862	698	781
	72"	1 ¼"	962	1,040	922	755	847
	84"	1 ¼"	1,025	1,107	984	813	911
	96"	1 ¼"	1,088	1,173	1,045	870	976
<b>RM4024MP</b>	60"	1 ½"	984	1,062	919	753	843
	72"	1 ½"	1,046	1,130	981	811	908
	84"	1 ½"	1,108	1,197	1,042	868	972
	96"	1 ½"	1,170	1,265	1,103	927	1,038
Offset Pulls - Round Ends							
<b>RM4034MP</b>	60"	1"	922	996	889	725	811
	72"	1"	985	1,063	951	782	876
	84"	1"	1,047	1,131	1,011	887	993
	96"	1"	1,109	1,199	1,073	992	1,112
<b>RM4044MP</b>	60"	1 ¼"	944	1,020	904	738	826
	72"	1 ¼"	1,007	1,087	965	797	891
	84"	1 ¼"	1,068	1,154	1,026	854	956
	96"	1 ¼"	1,131	1,221	1,088	912	1,021
<b>RM4054MP</b>	60"	1 ½"	1,027	1,109	961	794	888
	72"	1 ½"	1,090	1,177	1,023	851	953
	84"	1 ½"	1,152	1,244	1,084	909	1,018
	96"	1 ½"	1,214	1,311	1,145	966	1,082

• Add on will apply for Premium and Super Premium wood species, as well as any additional wood finishing. See page 39.

NOTE: Post location on push bars can be located 1/8" from end for narrow & medium stile doors and 1" from end for flush and wide stile doors.

**ASSA ABLOY**

Experience a safer  
and more open world

ArborTek - Wood Grip Pulls

Straight Pulls - Flat Ends							
Part	Max OA	Dia.	3/605 4/606	10/612 10B/613	Stock PC 10BE	32D/630	32/629
<b>RM4100</b>	12"	1"	359	388	358	246	277
	24"	1"	422	456	420	304	340
	36"	1"	483	522	480	361	405
	48"	1"	546	589	541	419	468
<b>RM4110</b>	12"	1 1/4"	379	410	384	271	304
	24"	1 1/4"	442	478	445	328	368
	36"	1 1/4"	505	545	506	386	432
	48"	1 1/4"	567	613	566	442	496
<b>RM4120</b>	12"	1 1/2"	464	501	431	315	353
	24"	1 1/2"	526	568	492	373	417
	36"	1 1/2"	588	635	553	430	483
	48"	1 1/2"	651	702	638	488	546
<b>Offset Pulls - Flat Ends</b>							
<b>RM4130</b>	12"	1"	403	435	401	287	321
	24"	1"	465	502	462	344	386
	36"	1"	527	569	522	401	449
	48"	1"	589	636	607	459	514
<b>RM4140</b>	12"	1 1/4"	424	458	426	311	347
	24"	1 1/4"	485	525	488	368	413
	36"	1 1/4"	548	591	548	425	477
	48"	1 1/4"	611	659	633	484	541
<b>RM4150</b>	12"	1 1/2"	507	548	474	355	398
	24"	1 1/2"	570	615	534	413	462
	36"	1 1/2"	632	683	620	470	526
	48"	1 1/2"	694	750	681	527	591
<b>Straight Pulls - Round Ends</b>							
<b>RM4104</b>	12"	1"	459	496	407	292	328
	24"	1"	520	562	467	349	392
	36"	1"	583	630	529	408	456
	48"	1"	646	696	614	464	520
<b>RM4114</b>	12"	1 1/4"	479	518	432	316	354
	24"	1 1/4"	542	585	493	374	419
	36"	1 1/4"	605	653	554	432	484
	48"	1 1/4"	667	720	639	489	547
<b>RM4124</b>	12"	1 1/2"	563	608	480	361	405
	24"	1 1/2"	625	676	541	419	468
	36"	1 1/2"	688	742	625	476	532
	48"	1 1/2"	750	810	687	534	598

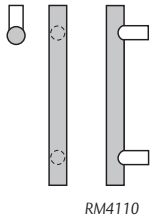

RM4110

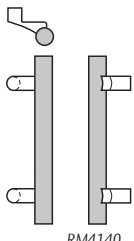

RM4140

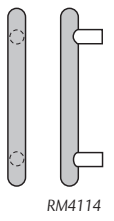

RM4114

• Add on will apply for Premium and Super Premium wood species, as well as any additional wood finishing. See page 39.

NOTE: Post location on push bars can be located 1/8" from end for narrow & medium stile doors and 1" from end for flush and wide stile doors.

ArborTek - Wood Grip Pulls (con't)

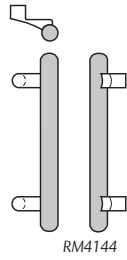

Offset Pulls - Round Ends							
Part	OA	Dia.	3/605 4/606	10/612 10B/613	Stock PC 10BE	32D/630	32/629
<b>RM4134</b>	12"	1"	502	543	449	333	373
	24"	1"	565	610	511	390	437
	36"	1"	626	677	571	447	501
	48"	1"	689	744	657	504	565
<b>RM4144</b>	12"	1 ¼"	523	566	475	357	399
	24"	1 ¼"	585	632	535	414	463
	36"	1 ¼"	648	700	621	471	528
	48"	1 ¼"	711	767	682	528	593
<b>RM4154</b>	12"	1 ½"	607	655	522	401	449
	24"	1 ½"	669	723	607	459	514
	36"	1 ½"	731	791	668	516	578
	48"	1 ½"	794	858	729	573	642

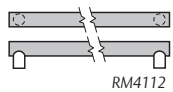

Push Bars - Flat Ends							
<b>RM4112</b>	Up to 36" CTC	1 ¼"	505	545	506	386	432
<b>RM4122</b>	Up to 36" CTC	1 ½"	588	635	553	430	483

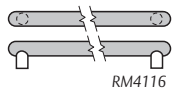

Push Bars - Round Ends							
<b>RM4116</b>	Up to 36" CTC	1 ¼"	605	653	554	432	484
<b>RM4126</b>	Up to 36" CTC	1 ½"	688	742	625	476	532

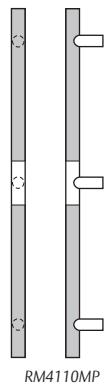

Straight Pulls - Flat Ends							
Part	Max OA	Dia.	3/605 4/606	10/612 10B/613	Stock PC 10BE	32D/630	32/629
<b>RM4100MP</b>	60"	1"	655	707	652	524	587
	72"	1"	718	774	713	582	651
	84"	1"	779	842	775	640	717
	96"	1"	842	909	836	698	780
<b>RM4110MP</b>	60"	1 ¼"	676	730	677	547	614
	72"	1 ¼"	738	797	739	605	678
	84"	1 ¼"	800	865	800	662	743
	96"	1 ¼"	863	932	862	721	808
<b>RM4120MP</b>	60"	1 ½"	760	820	749	593	664
	72"	1 ½"	823	887	810	650	728
	84"	1 ½"	884	955	871	708	794
	96"	1 ½"	947	1,022	933	765	857

• Add on will apply for Premium and Super Premium wood species, as well as any additional wood finishing. See page 39.  
 NOTE: Post location on push bars can be located 1/8" from end for narrow & medium stile doors and 1" from end for flush and wide stile doors.

ArborTek - Wood Grip Pulls (con't)

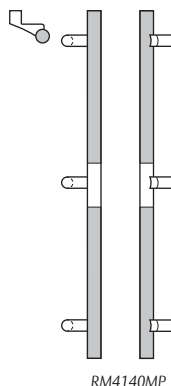

Offset Pulls - Flat Ends							
Part	Max OA	Dia.	3/605 4/606	10/612 10B/613	Stock PC 10BE	32D/630	32/629
<b>RM4130MP</b>	60"	1"	699	755	719	564	631
	72"	1"	761	823	780	622	697
	84"	1"	824	888	842	679	760
	96"	1"	885	956	903	737	826
<b>RM4140MP</b>	60"	1 1/4"	720	995	744	589	658
	72"	1 1/4"	781	845	806	646	723
	84"	1 1/4"	844	912	867	704	788
	96"	1 1/4"	906	979	929	761	853
<b>RM4150MP</b>	60"	1 1/2"	803	868	792	632	708
	72"	1 1/2"	866	935	852	691	773
	84"	1 1/2"	929	1,003	914	748	838
	96"	1 1/2"	990	1,068	975	806	903

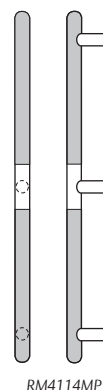

Straight Pulls - Round Ends							
<b>RM4104MP</b>	60"	1"	755	814	725	569	638
	72"	1"	816	882	785	627	703
	84"	1"	879	950	847	685	766
	96"	1"	941	1,017	908	743	832
<b>RM4114MP</b>	60"	1 1/4"	776	837	750	594	665
	72"	1 1/4"	838	905	811	651	730
	84"	1 1/4"	901	973	872	709	795
	96"	1 1/4"	962	1,040	934	766	859
<b>RM4124MP</b>	60"	1 1/2"	860	929	798	639	716
	72"	1 1/2"	921	995	860	697	779
	84"	1 1/2"	984	1,062	920	754	844
	96"	1 1/2"	1,046	1,130	982	812	909

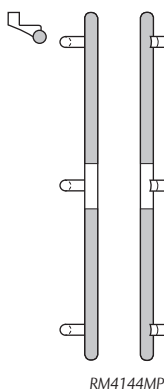

Offset Pulls - Round Ends							
<b>RM4134MP</b>	60"	1"	798	863	769	609	683
	72"	1"	861	930	829	667	748
	84"	1"	922	996	890	725	812
	96"	1"	985	1,063	952	782	877
<b>RM4144MP</b>	60"	1 1/4"	820	885	793	633	710
	72"	1 1/4"	882	952	853	692	774
	84"	1 1/4"	944	1,020	915	749	839
	96"	1 1/4"	1,007	1,087	976	807	905
<b>RM4154MP</b>	60"	1 1/2"	903	975	841	678	759
	72"	1 1/2"	966	1,043	902	736	825
	84"	1 1/2"	1,027	1,109	962	795	889
	96"	1 1/2"	1,090	1,177	1,024	852	954

• Add on will apply for Premium and Super Premium wood species, as well as any additional wood finishing. See page 39.

NOTE: Post location on push bars can be located 1/8" from end for narrow & medium stile doors and 1" from end for flush and wide stile doors.

### ArborTek - Wood Grip Pulls (con't)

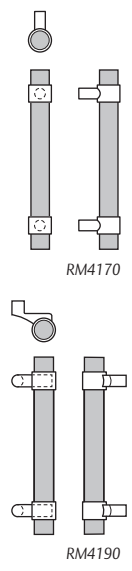

Wood Pulls with Collar Mount Posts							
Straight Pulls - Flat Ends							
Part	Max OA	Dia.	3/605 4/606	10/612 10B/613	Stock PC 10BE	32D/630	32/629
RM4160	12"	1"	527	570	551	427	479
	24"	1"	610	658	631	503	564
	36"	1"	690	744	710	578	647
	48"	1"	775	837	793	656	735
RM4170	12"	1 1/4"	536	579	559	436	489
	24"	1 1/4"	634	686	654	526	590
	36"	1 1/4"	731	791	750	616	690
	48"	1 1/4"	801	865	818	679	761
Offset Pulls - Flat Ends							
RM4180	12"	1"	584	632	606	480	538
	24"	1"	674	727	693	563	630
	36"	1"	764	826	781	646	724
	48"	1"	826	890	842	702	785
RM4190	12"	1 1/4"	590	638	613	487	545
	24"	1 1/4"	696	753	716	584	653
	36"	1 1/4"	802	867	819	681	762
	48"	1 1/4"	844	911	860	720	805

- Add on will apply for Premium and Super Premium wood species, as well as any additional wood finishing.

NOTE: Post location on push bars can be located 1/8" from end for narrow & medium stile doors and 1" from end for flush and wide stile doors.

Wood Species	
<b>Domestic (Standard)</b>	Hickory, White Oak, Red Oak, Maple
<b>Premium</b>	Beech, Cherry, Birch
<b>Super Premium</b>	Mahogany, Jatoba (Brazilian Cherry), Canary, Walnut

### Wood Add On

Wood Species	Wood Dia	Add On	Wood Species	Wood Dia	Add On	Finish	Add On
Premium	1"	24	Super Premium	1"	60	Clear	200
	1 1/4"	40		1 1/4"	80	Dyed	200
	1 1/2"	60		1 1/2"	100	Tung Oil	65

- Wood is a natural material, colors and grain will vary between pulls.
- Other wood species are available by request.
- Hickory, sanded unfinished is the stock species; other wood types will require longer lead times and may be subject to availability,

### SkewTek - Angled End Pulls

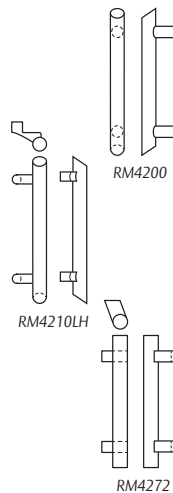







Straight Pull - Forward Segment									
Part	Max OA	Dia.	28/628	313/710 315/711	3/605 4/606	10/612 10B/613	Stock PC 10BE	32D/630	32/629
RM4200-11	16"	1 1/2"	525	577	678	731	577	470	527
Offset Pulls - Forward Segment									
RM4210LH-11	16"	1 1/2"	562	619	721	777	637	506	567
RM4210RH-11	16"	1 1/2"	562	619	721	777	637	506	567
Straight Pulls - Rectangular Posts									
RM4270-12	18"	2"	749	801	1,129	1,220	876	740	829
RM4270-24	30"	2"	819	874	1,234	1,332	962	826	924
Offset Pulls - Rectangular Posts									
RM4272-12	18"	2"	925	980	1,304	1,409	1,021	882	987
RM4272-24	30"	2"	998	1,050	1,407	1,519	1,133	969	1,083
Straight Pulls - Round Posts									
RM4274-12	18"	2"	749	801	1,129	1,220	876	740	829
RM4274-24	30"	2"	819	874	1,234	1,332	962	826	924

- Add \$6.50/in. over 30".

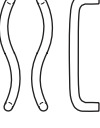
**ASSA ABLOY**

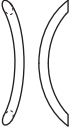
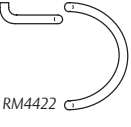
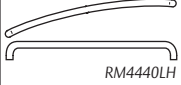
Experience a safer  
and more open world

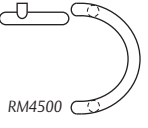
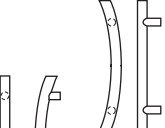
## CenTrex - Shaped Pulls

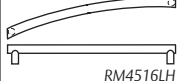
Curved Pulls										
Part	CTC	28/628	313/710 315/711	3/605 4/606	10/612 10B/613	Stock PC 10BE	26/625 26D/626	32D/630	32/629	
 RM4400	RM4400-12	12"	393	414	590	639	492	590	374	418
	RM4400-20	20"	410	431	655	707	508	655	389	436
Double Curved Pulls										
 RM4402LH	RM4402LH	12"	471	491	655	707	544	655	422	474
	RM4402RH	12"	471	491	655	707	544	655	422	474
Straight Radius Pulls										
 RM4410	RM4410-12	12"	348	368	590	639	438	590	321	360
	RM4410-18	18"	368	390	655	707	457	655	339	381
	RM4410-24	24"	390	410	716	772	492	716	374	418
Offset Radius Pulls										
 RM4412	RM4412-12	12"	431	450	676	729	508	676	389	436
	RM4412-18	18"	450	471	734	793	528	734	407	457
	RM4412-24	24"	471	491	796	860	562	796	440	493
Semi-Circular Pulls										
 RM4422	RM4420	9"	268	288		531	368	492	255	285
	RM4422	12"	288	309		551	386	511	275	306
Radius Push Bars										
 RM4440LH	RM4440LH	Up to 36"	511	533	899	971	749	899	594	664
	RM4440RH	Up to 36"	511	533	899	971	749	899	594	664
Compound Radius Push Bars										
 RM4450LH	RM4450LH	Up to 36"	1,018	1,081	659	1,389	1,129	1,286	930	1,042
	RM4450RH	Up to 36"	1,018	1,081	659	1,389	1,129	1,286	930	1,042
Semi-Circular Pulls										
 RM4500	RM4500	11"	410	431	817	882	603		456	510
	RM4502	11"	410	431	817	882	603		456	510
	RM4506	12"			532	576	473		356	398
Side Radius Pull										
 RM4510	RM4510	12"	450	491	613	661	544		422	474
Projecting Radius Pull										
 RM4512	RM4512	12"			899	971	693		541	605
Radius Push Bars										
 RM4516LH	RM4516LH	Up to 36"	552	592	796	860	639		490	548
	RM4516RH	Up to 36"	552	592	796	860	639		490	548

NOTE: Post location on push bars can be located  $\frac{1}{8}$ " from end for narrow & medium stile doors and 1" from end for flush and wide stile doors.

**ASSA ABLOY**

Experience a safer  
and more open world

USA & Canada Prices Effective March 16, 2020

Copyright © 2020, ASSA ABLOY Accessories and Door Controls Group, Inc. All rights reserved. Reproduction in whole or in part without the express written permission of ASSA ABLOY Accessories and Door Controls Group, Inc. is prohibited.



### AccenTek™ - Solid Pulls with Accents

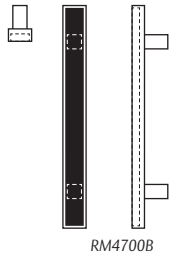

RM4700B

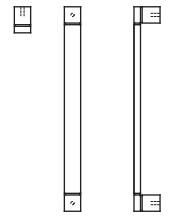

RM4750

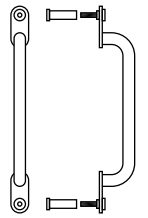

RM4800

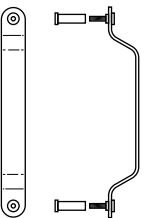

RM4820

Cast Pulls									
Part	Grip	CTC	Stock PC 10BE	3/605 4/606	10/612 10A/722	10B/613 10BL/614	15/619 15A/620	20A/624	26/625 26D/626
RM4720	1 1/2" x 1/2" x 12 1/2"	8"	491	465	504	504	504	504	504
RM4700W	1 1/4" x 5/8" x 14"	10"	570	542	584	584	584	584	584
RM4700B	1 1/4" x 5/8" x 14"	10"	570	542	584	584	584	584	584
Solid Groove Pulls									
Part	Grip	CTC	32D/630	32/629					
RM4750	1/2" x 1 1/4"	12"	340	383					
	1/2" x 1 1/4"	24"	395	441					
	1/2" x 1 1/4"	36"	448	502					
	1/2" x 1 1/4"	48"	501	561					
RM4755	3/4" x 1 1/4"	12"	387	433					
	3/4" x 1 1/4"	24"	440	493					
	3/4" x 1 1/4"	36"	495	553					
	3/4" x 1 1/4"	48"	547	613					
Formed Pulls with Distinguished Fastener Heads									
Part	Grip	CTC	Wrought Black	Stock PC 10BE	Black Suede	32D/630	Industrial Steel		
RM4800	3/4" Dia	12"	413	413	413	361			
		16"	413	413	413	361	437		
		24"	479	479	479	427			
		36"	624	624	624	547			
RM4810	1 1/2" x 1/4"	12"	340	340	340	292			
		16"	340	340	340	292	360		
		24"	395	395	395	346			
		36"	515	515	515	442			
RM4820	1 1/2" x 3/16"	12"	413	413	413	361			
		16"	413	413	413	361	437		
		24"	479	479	479	427			
		36"	624	624	624	547			
RM4800 x RM4810		12"	754	754	754	653			
		16"	754	754	754	653	797		
		24"	875	875	875	773			
		36"	1,140	1,140	1,140	988			
RM4820 x RM4810		12"	754	754	754	653			
		16"	754	754	754	653	797		
		24"	875	875	875	773			
		36"	1,140	1,140	1,140	988			

- RM4700 pulls contain white or black polycarbonate insert.
- RM4750 & RM4755 pulls add \$9.70/in. over 48". CTC up to 60".
- RM4800 series, US32D and US10BE come with Socket Head Screws. Other finishes come with Hex Head Screws.
- RM4800 series longer lengths may be offered, call factory for pricing.
- Specify CTC when ordering.

PlanTek - Flat Front Pulls

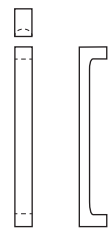

Straight Cast Pulls								
Part	CTC	Grip Size	3/605 4/606	10/612 10B/613	Stock PC 10BE	26/625 26D/626	32D/630	32/629
RM5200-7	7"	1"	292	314	295	292		
RM5200-12	12"	1"	336	363	340	336		
RM5202	12"	1 1/4"	424	458	429	424		

RM5200



Offset Cast Pulls								
Radius End Pulls								
RM5204-8	8"	1"	292	314	295	292		
RM5204-12	12"	1"	336	363	340	336		
RM5210-10	10"	1/2" x 1 1/4"	597	645	459		340	383
RM5210-12	12"	1/2" x 1 1/4"	621	671	476		358	400
RM5220-12	12"	3/4" x 1 1/2"	797	861	511		390	437
RM5220-18	18"	3/4" x 1 1/2"	888	959	565		441	495

RM5210

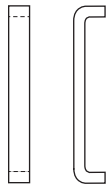

Square End Pulls								
RM5230-10	10"	1/2" x 1 1/4"	553	597	370		257	288
RM5230-12	12"	1/2" x 1 1/4"	579	625	386		274	305
RM5240-12	12"	3/4" x 1 1/2"	732	792	405		290	324
RM5240-18	18"	3/4" x 1 1/2"	819	886	422		307	344

RM5250

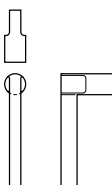

Bent End Pulls								
RM5250-10	10"	1/2" x 1 1/4"	447	482	352		239	268
RM5250-12	12"	1/2" x 1 1/4"	467	503	370		257	288
RM5260-12	12"	3/4" x 1 1/2"	597	645	422		307	344
RM5260-18	18"	3/4" x 1 1/2"	708	765	459		340	383

RM5270

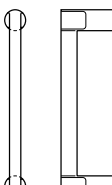

Radius End Pulls								
RM5270-10	10"	1/2" x 3/4"			441		324	363
RM5270-12	12"	1/2" x 3/4"			454		337	379
RM5270-16	16"	1/2" x 3/4"			488		368	413

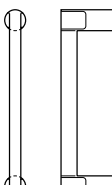

Straight Cast Pull								
RM5280	9"	1/2" x 1/2"	136	146	137	136		

Push Bars - Radius Ends								
RM5212	Up to 36"	1/2" x 1 1/4"	819	886	546		423	475
RM5222	Up to 36"	3/4" x 1 1/2"	1,239	1,338	752		595	665

Push Bars - Flat Ends								
RM5232	Up to 36"	1/2" x 1 1/4"	819	886	476		358	400
RM5242	Up to 36"	3/4" x 1 1/2"	1,218	1,317	565		441	495

- Add \$9.70/in. over 36".
- RM5200, RM5202, RM5204 CTC can not be modified.

NOTE: Post location on push bars can be located 1/8" from end for narrow & medium stile doors and 1" from end for flush and wide stile doors.

## Traditional - Decorative Pulls & Plates

Add pull price to plate price to make pull plate combination.

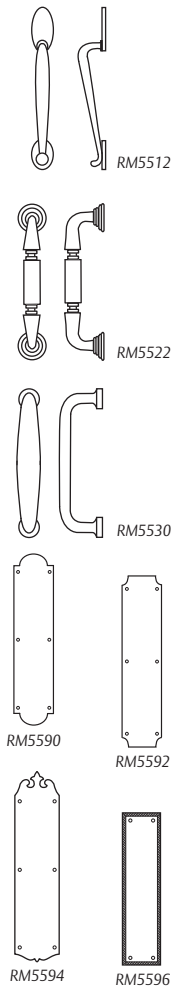

Cast Pulls							
Part	CTC	Base Plate	3/605 4/606	10/612 10B/613	Stock PC 10BE	15/619 15A/620	26/625 26D/626
RM5500	6"	no	113	121	112	127	113
RM5502	6 7/8"	yes	185	198	183	211	203
RM5510	12"	no	185	198	183	237	220
RM5512	12 7/8"	yes	257	279	259	326	294
Cast Pulls							
RM5520	8"	no	165	179	165	183	165
RM5522	8"	yes	203	218	201	218	203
Cast Pulls							
Part	Size		3/605 4/606	10/612 10B/613	Stock PC 10BE	15/619 15A/620	26/625 26D/626
RM5530	5 1/2"		58	63	58	70	58
RM5532	7 1/2"		84	91	85	96	90
RM5534	12"		249	269	249	264	249
Heavy Decorative Plates - .090" Thick							
RM5590A	3" x 12"		97	107	99	118	108
RM5590B	3 1/2" x 15"		108	117	108	125	119
RM5590C	4" x 16"		119	129	119	136	126
Heavy Decorative Plates - .090" Thick							
RM5592A	3" x 12"		97	107	99	118	
RM5592B	3 1/2" x 15"		108	117	108	125	
RM5592C	4" x 16"		119	129	119	136	
Heavy Decorative Plates - .090" Thick							
RM5594B	3 1/2" x 15"		195	211	196	212	203
Rope Border Cast Plates							
RM5596A	3" x 12"		119	129	119	125	119
RM5596B	3 1/2" x 15"		137	149	137	144	137
Plain Cast Plate - 5/16" Thick							
RM5598B	3 1/2" x 15"		157	167	156	162	157

## Classic - Finial Door Pulls

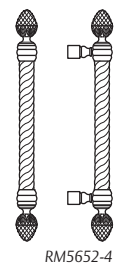

1" Door Pulls								
Part	CTC	Grip	Base Plate	3/605 4/606	10/612 10B/613	Stock PC 10BE	15/619 15A/620	26/625 26D/626
RM5650	10"	Plain	no	390	422	410	459	430
RM5652	10"	Rope	no	390	422	410	459	430
RM5654	10"	Fluted	no	390	422	410	459	430
RM5660	10"	Plain	yes	436	470	459	506	476
RM5662	10"	Rope	yes	436	470	459	506	476
RM5664	10"	Fluted	yes	436	470	459	506	476
1" Offset Door Pull								
RM5670	10"	Plain	no	440	476	464	488	479

- To order suffix finial style number.
- Add \$6.50/in. for longer pulls up to 36".

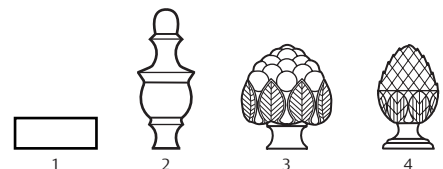

Finial Style Number (example: RM5650-4)

Suffix	Finial Style:
1	Plain
2	Urn
3	Berry
4	Pinecone

## MariTek - Tapered Pulls

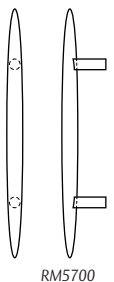

Straight Door Pulls						
Part	CTC	3/605 4/606	10B/613	Stock PC 10BE	14/618 15/619	26/625 26D/626
RM5700	6"	288	308	303	295	305
RM5702	12"	305	329	320	313	321

**ASSA ABLOY**

Experience a safer  
and more open world

English Bridle Leather Pulls

Straight Pulls - Flat Ends							
Part	Max OA	Dia.	3/605 4/606	10/612 10B/613	Stock PC 10BE	32D/630	32/629
<b>RM6060</b>	12"	1"	761	823	684	577	647
	24"	1"	1,128	1,219	999	870	976
	36"	1"	1,496	1,614	1,293	1,165	1,304
	48"	1"	1,862	2,010	1,588	1,460	1,636
	60"	1"	2,243	2,422	1,884	1,756	1,967
	72"	1"	2,623	2,833	2,180	2,051	2,297
	84"	1"	2,835	3,062	2,292	2,164	2,423
	96"	1"	3,046	3,291	2,406	2,278	2,550
	<b>RM6061</b>	12"	1 1/4"	849	916	776	669
24"		1 1/4"	1,381	1,491	1,215	1,086	1,217
36"		1 1/4"	1,914	2,066	1,633	1,504	1,684
48"		1 1/4"	2,352	2,541	1,997	1,868	2,092
60"		1 1/4"	2,791	3,014	2,361	2,233	2,500
72"		1 1/4"	2,933	3,168	2,498	2,369	2,653
84"		1 1/4"	3,073	3,320	2,634	2,505	2,807
96"		1 1/4"	3,215	3,472	2,749	2,620	2,935
<b>RM6062</b>		12"	1 1/2"	966	1,043	872	764
	24"	1 1/2"	1,541	1,665	1,347	1,218	1,363
	36"	1 1/2"	2,115	2,285	1,799	1,671	1,871
	48"	1 1/2"	2,581	2,787	2,011	1,883	2,109
	60"	1 1/2"	3,046	3,291	2,224	2,096	2,347
	72"	1 1/2"	3,216	3,474	2,437	2,309	2,584
	84"	1 1/2"	3,386	3,657	2,649	2,521	2,823
	96"	1 1/2"	3,556	3,841	2,861	2,733	3,061
	Offset Pulls - Flat Ends						
<b>RM6070</b>	12"	1"	799	863	717	609	682
	24"	1"	1,166	1,258	1,032	903	1,011
	36"	1"	1,533	1,655	1,325	1,197	1,341
	48"	1"	1,899	2,051	1,620	1,492	1,671
	60"	1"	2,281	2,463	1,917	1,788	2,002
	72"	1"	2,661	2,874	2,212	2,083	2,333
	84"	1"	2,872	3,102	2,324	2,196	2,460
	96"	1"	3,084	3,330	2,438	2,310	2,586
	<b>RM6071</b>	12"	1 1/4"	886	957	808	701
24"		1 1/4"	1,419	1,532	1,247	1,118	1,252
36"		1 1/4"	1,951	2,107	1,665	1,536	1,720
48"		1 1/4"	2,390	2,580	2,029	1,900	2,129
60"		1 1/4"	2,829	3,056	2,393	2,264	2,537
72"		1 1/4"	2,970	3,207	2,530	2,401	2,688
84"		1 1/4"	3,111	3,360	2,667	2,538	2,842
96"		1 1/4"	3,252	3,512	2,781	2,652	2,970
<b>RM6072</b>		12"	1 1/2"	1,004	1,084	904	797
	24"	1 1/2"	1,579	1,705	1,379	1,250	1,400
	36"	1 1/2"	2,153	2,325	1,831	1,704	1,907
	48"	1 1/2"	2,619	2,828	2,044	1,916	2,146
	60"	1 1/2"	3,084	3,330	2,256	2,128	2,384
	72"	1 1/2"	3,253	3,513	2,469	2,341	2,621
	84"	1 1/2"	3,424	3,697	2,681	2,552	2,859
	96"	1 1/2"	3,593	3,880	2,893	2,764	3,097

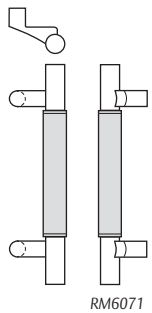
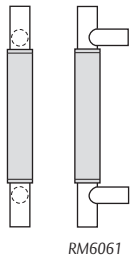

- Add \$6.50/in. over 96".
- MP (Mid Post) - Add \$76 each. (Recommended for maximum rigidity on long door pulls. See page 5 for guidelines.)
- FW (Full Wrap) available up to 72" overall length pull - Call for pricing.
- Specify leather color.

NOTE: All long pulls include charge for leather between mounting posts up to a maximum of 72" of leather cover.

**ASSA ABLOY**

Experience a safer  
and more open world

English Bridle Leather Pulls (con't)

Straight Pulls - Round Ends							
Part	Max OA	Dia.	3/605 4/606	10/612 10B/613	Stock PC 10BE	32D/630	32/629
<b>RM6080</b>	12"	1"	843	911	722	615	688
	24"	1"	1,128	1,219	1,037	908	1,018
	36"	1"	1,496	1,614	1,330	1,202	1,347
	48"	1"	1,862	2,010	1,627	1,498	1,678
	60"	1"	2,243	2,422	1,922	1,793	2,008
	72"	1"	2,623	2,833	2,217	2,089	2,340
	84"	1"	2,835	3,062	2,330	2,202	2,466
	96"	1"	3,046	3,291	2,443	2,315	2,593
	<b>RM6081</b>	12"	1 1/4"	849	916	813	706
24"		1 1/4"	1,381	1,491	1,252	1,123	1,258
36"		1 1/4"	1,914	2,066	1,670	1,541	1,726
48"		1 1/4"	2,352	2,541	2,034	1,905	2,134
60"		1 1/4"	2,791	3,014	2,398	2,270	2,542
72"		1 1/4"	2,933	3,168	2,536	2,407	2,695
84"		1 1/4"	3,073	3,320	2,672	2,543	2,849
96"		1 1/4"	3,215	3,472	2,786	2,657	2,976
<b>RM6082</b>		12"	1 1/2"	966	1,043	909	802
	24"	1 1/2"	1,541	1,665	1,384	1,255	1,406
	36"	1 1/2"	2,115	2,285	1,837	1,709	1,914
	48"	1 1/2"	2,581	2,787	2,049	1,921	2,151
	60"	1 1/2"	3,046	3,291	2,261	2,133	2,389
	72"	1 1/2"	3,216	3,474	2,474	2,346	2,627
	84"	1 1/2"	3,386	3,657	2,686	2,558	2,864
	96"	1 1/2"	3,556	3,841	2,898	2,771	3,102
	Offset Pulls - Round Ends						
<b>RM6090</b>	12"	1"	880	951	754	647	724
	24"	1"	1,246	1,346	1,069	940	1,052
	36"	1"	1,613	1,742	1,362	1,234	1,382
	48"	1"	1,979	2,138	1,658	1,530	1,713
	60"	1"	2,361	2,549	1,954	1,825	2,044
	72"	1"	2,741	2,961	2,250	2,121	2,376
	84"	1"	2,954	3,189	2,362	2,234	2,501
	96"	1"	3,165	3,417	2,475	2,347	2,629
	<b>RM6091</b>	12"	1 1/4"	966	1,043	846	738
24"		1 1/4"	1,499	1,618	1,284	1,155	1,294
36"		1 1/4"	2,031	2,193	1,702	1,574	1,762
48"		1 1/4"	2,470	2,668	2,066	1,938	2,170
60"		1 1/4"	2,909	3,142	2,430	2,302	2,578
72"		1 1/4"	3,050	3,294	2,568	2,439	2,732
84"		1 1/4"	3,191	3,448	2,704	2,575	2,884
96"		1 1/4"	3,332	3,599	2,818	2,689	3,012
<b>RM6092</b>		12"	1 1/2"	1,084	1,171	941	834
	24"	1 1/2"	1,659	1,791	1,416	1,288	1,441
	36"	1 1/2"	2,234	2,413	1,869	1,741	1,950
	48"	1 1/2"	2,700	2,915	2,081	1,953	2,187
	60"	1 1/2"	3,165	3,417	2,293	2,165	2,425
	72"	1 1/2"	3,333	3,600	2,506	2,378	2,663
	84"	1 1/2"	3,504	3,784	2,719	2,591	2,901
	96"	1 1/2"	3,673	3,967	2,931	2,802	3,139

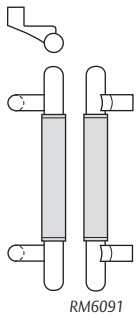
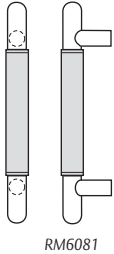

- Add \$6.50/in. over 96".
- MP (Mid Post) - Add \$76 each. (Recommended for maximum rigidity on long door pulls. See page 5 for guidelines.)
- FW (Full Wrap) available up to 72" overall length pull - Call for pricing.
- Specify leather color.

NOTE: All long pulls include charge for leather between mounting posts up to a maximum of 72" of leather cover.

**ASSA ABLOY**

Experience a safer  
and more open world

Upholstery Leather Pulls

Straight Pulls - Flat Ends								
Part	Max OA	Dia.	3/605 4/606	10/612 10B/613	Stock PC 10BE	32D/630	32/629	
<b>RM6160</b>	12"	1"	714	773	641	530	595	
	24"	1"	1,012	1,093	836	726	813	
	36"	1"	1,399	1,511	1,161	1,029	1,152	
	48"	1"	1,785	1,927	1,465	1,333	1,492	
	60"	1"	2,062	2,228	1,642	1,509	1,690	
	72"	1"	2,464	2,661	1,946	1,814	2,031	
	84"	1"	2,632	2,842	2,049	1,917	2,146	
	96"	1"	2,854	3,083	2,166	2,033	2,278	
	<b>RM6161</b>	12"	1 1/4"	803	867	705	595	667
		24"	1 1/4"	1,401	1,513	1,205	1,072	1,201
36"		1 1/4"	1,962	2,120	1,635	1,503	1,683	
48"		1 1/4"	2,425	2,620	2,010	1,878	2,103	
60"		1 1/4"	2,765	2,986	2,290	2,158	2,417	
72"		1 1/4"	2,914	3,147	2,432	2,299	2,575	
84"		1 1/4"	3,062	3,307	2,540	2,408	2,697	
96"		1 1/4"	3,212	3,468	2,658	2,525	2,829	
<b>RM6162</b>		12"	1 1/2"	912	986	753	642	720
		24"	1 1/2"	1,518	1,640	1,348	1,216	1,361
	36"	1 1/2"	2,124	2,293	1,815	1,683	1,884	
	48"	1 1/2"	2,615	2,824	2,033	1,901	2,130	
	60"	1 1/2"	3,104	3,353	2,252	2,120	2,374	
	72"	1 1/2"	3,283	3,546	2,471	2,339	2,620	
	84"	1 1/2"	3,463	3,740	2,689	2,557	2,864	
	96"	1 1/2"	3,641	3,932	2,909	2,776	3,110	
	Offset Pulls - Flat Ends							
	<b>RM6170</b>	12"	1"	754	814	674	564	631
24"		1"	1,051	1,135	869	759	851	
36"		1"	1,438	1,554	1,194	1,062	1,189	
48"		1"	1,824	1,970	1,499	1,366	1,530	
60"		1"	2,102	2,270	1,674	1,542	1,727	
72"		1"	2,503	2,703	1,979	1,847	2,069	
84"		1"	2,672	2,885	2,082	1,950	2,184	
96"		1"	2,893	3,125	2,199	2,066	2,315	
<b>RM6171</b>		12"	1 1/4"	842	910	738	628	703
		24"	1 1/4"	1,440	1,556	1,238	1,106	1,238
	36"	1 1/4"	2,002	2,162	1,668	1,536	1,720	
	48"	1 1/4"	2,465	2,662	2,044	1,910	2,140	
	60"	1 1/4"	2,805	3,030	2,323	2,191	2,453	
	72"	1 1/4"	2,954	3,190	2,465	2,333	2,611	
	84"	1 1/4"	3,101	3,350	2,573	2,441	2,733	
	96"	1 1/4"	3,250	3,510	2,692	2,558	2,865	
	<b>RM6172</b>	12"	1 1/2"	952	1,028	785	675	756
		24"	1 1/2"	1,558	1,683	1,381	1,249	1,399
36"		1 1/2"	2,163	2,336	1,848	1,716	1,922	
48"		1 1/2"	2,654	2,866	2,066	1,934	2,166	
60"		1 1/2"	3,144	3,397	2,285	2,153	2,411	
72"		1 1/2"	3,323	3,588	2,504	2,372	2,657	
84"		1 1/2"	3,503	3,782	2,723	2,591	2,902	
96"		1 1/2"	3,681	3,975	2,941	2,809	3,147	

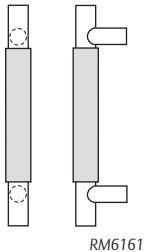

RM6160

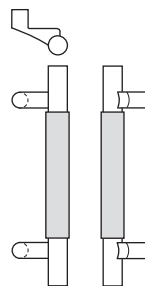

RM6171

- Add \$6.50/in. over 96".
- MP (Mid Post) - Add \$76 each. (Recommended for maximum rigidity on long door pulls. See page 5 for guidelines.)
- FW (Full Wrap) available up to 72" overall length pull - Call for pricing.
- Specify leather color.

NOTE: All long pulls include charge for leather between mounting posts up to a maximum of 72" of leather cover.

Upholstery Leather Pulls (con't)

Straight Pulls - Round Ends							
Part	Max OA	Dia.	3/605 4/606	10/612 10B/613	Stock PC 10BE	32D/630	32/629
<b>RM6180</b>	12"	1"	800	863	680	569	638
	24"	1"	1,096	1,185	875	764	856
	36"	1"	1,484	1,602	1,199	1,067	1,195
	48"	1"	1,870	2,019	1,504	1,372	1,536
	60"	1"	2,148	2,319	1,681	1,548	1,734
	72"	1"	2,548	2,753	1,985	1,852	2,074
	84"	1"	2,716	2,933	2,087	1,955	2,190
	96"	1"	2,939	3,174	2,205	2,072	2,320
	<b>RM6181</b>	12"	1 1/4"	887	959	744	633
24"		1 1/4"	1,486	1,605	1,244	1,111	1,245
36"		1 1/4"	2,047	2,211	1,673	1,541	1,726
48"		1 1/4"	2,510	2,711	2,049	1,917	2,146
60"		1 1/4"	2,850	3,077	2,330	2,196	2,461
72"		1 1/4"	2,998	3,239	2,470	2,338	2,619
84"		1 1/4"	3,147	3,399	2,578	2,446	2,739
96"		1 1/4"	3,296	3,560	2,697	2,565	2,872
<b>RM6182</b>		12"	1 1/2"	997	1,077	791	681
	24"	1 1/2"	1,604	1,732	1,387	1,254	1,405
	36"	1 1/2"	2,208	2,385	1,853	1,721	1,927
	48"	1 1/2"	2,700	2,915	2,072	1,940	2,173
	60"	1 1/2"	3,190	3,444	2,290	2,158	2,417
	72"	1 1/2"	3,368	3,638	2,511	2,377	2,663
	84"	1 1/2"	3,547	3,831	2,729	2,596	2,907
	96"	1 1/2"	3,726	4,024	2,947	2,814	3,152
	<b>Offset Pulls - Round Ends</b>						
<b>RM6190</b>	12"	1"	839	906	712	602	675
	24"	1"	1,136	1,226	908	798	893
	36"	1"	1,524	1,645	1,232	1,100	1,232
	48"	1"	1,909	2,061	1,537	1,405	1,574
	60"	1"	2,187	2,362	1,714	1,581	1,771
	72"	1"	2,588	2,794	2,018	1,886	2,112
	84"	1"	2,756	2,976	2,121	1,988	2,227
	96"	1"	2,979	3,217	2,238	2,105	2,358
	<b>RM6191</b>	12"	1 1/4"	927	1,002	777	667
24"		1 1/4"	1,526	1,647	1,276	1,144	1,281
36"		1 1/4"	2,086	2,254	1,707	1,575	1,763
48"		1 1/4"	2,549	2,754	2,082	1,950	2,184
60"		1 1/4"	2,889	3,121	2,362	2,230	2,498
72"		1 1/4"	3,038	3,281	2,503	2,371	2,655
84"		1 1/4"	3,187	3,441	2,611	2,479	2,777
96"		1 1/4"	3,335	3,602	2,730	2,597	2,909
<b>RM6192</b>		12"	1 1/2"	1,037	1,119	824	713
	24"	1 1/2"	1,643	1,772	1,420	1,288	1,442
	36"	1 1/2"	2,247	2,427	1,887	1,754	1,965
	48"	1 1/2"	2,739	2,958	2,105	1,973	2,210
	60"	1 1/2"	3,229	3,487	2,323	2,191	2,453
	72"	1 1/2"	3,407	3,680	2,543	2,411	2,700
	84"	1 1/2"	3,587	3,874	2,761	2,629	2,945
	96"	1 1/2"	3,766	4,066	2,980	2,848	3,190

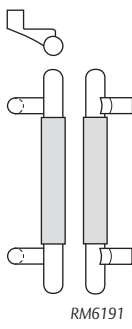
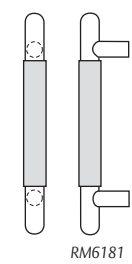

- Add \$6.50/in. over 96".
- MP (Mid Post) - Add \$76 each. (Recommended for maximum rigidity on long door pulls. See page 5 for guidelines.)
- FW (Full Wrap) available up to 72" overall length pull - Call for pricing.
- Specify leather color.

NOTE: All long pulls include charge for leather between mounting posts up to a maximum of 72" of leather cover.

**ASSA ABLOY**

Experience a safer  
and more open world

Leather Oval - Ergonomic Pulls

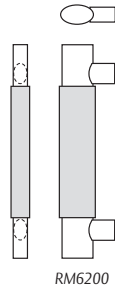

True Oval					
Part	Max OA	Grip Size	Stock PC 10BE	32D/630	32/629
RM6200	12"	1" x 1 1/2"	906	799	895
	24"	1" x 1 1/2"	1,269	1,140	1,276
	36"	1" x 1 1/2"	1,609	1,480	1,658
	48"	1" x 1 1/2"	1,950	1,821	2,039
	60"	1" x 1 1/2"	2,290	2,162	2,421
	72"	1" x 1 1/2"	2,631	2,502	2,803
	84"	1" x 1 1/2"	2,971	2,843	3,184
	96"	1" x 1 1/2"	3,312	3,183	3,565

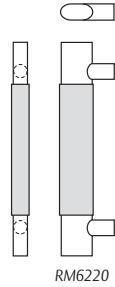

Flat Oval - 3/4" Diameter Posts					
Part	Max OA	Grip Size	Stock PC 10BE	32D/630	32/629
RM6220	12"	3/4" x 1 1/2"	944	837	938
	24"	3/4" x 1 1/2"	1,301	1,173	1,314
	36"	3/4" x 1 1/2"	1,637	1,508	1,689
	48"	3/4" x 1 1/2"	1,972	1,844	2,064
	60"	3/4" x 1 1/2"	2,308	2,179	2,440
	72"	3/4" x 1 1/2"	2,643	2,514	2,815
	84"	3/4" x 1 1/2"	2,978	2,850	3,192
	96"	3/4" x 1 1/2"	3,313	3,184	3,567

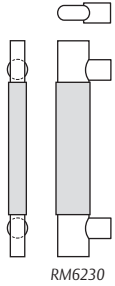

Flat Oval - 1" Diameter Posts					
Part	Max OA	Grip Size	Stock PC 10BE	32D/630	32/629
RM6230	12"	3/4" x 1 1/2"	999	870	976
	24"	3/4" x 1 1/2"	1,334	1,206	1,351
	36"	3/4" x 1 1/2"	1,670	1,541	1,726
	48"	3/4" x 1 1/2"	2,005	1,877	2,102
	60"	3/4" x 1 1/2"	2,341	2,212	2,477
	72"	3/4" x 1 1/2"	2,676	2,547	2,853
	84"	3/4" x 1 1/2"	3,011	2,883	3,228
	96"	3/4" x 1 1/2"	3,347	3,218	3,604

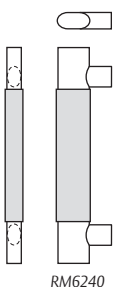

Flat Oval - 3/4" x 1 1/2" Diameter Posts					
Part	Max OA	Grip Size	Stock PC 10BE	32D/630	32/629
RM6240	12"	3/4" x 1 1/2"	1,126	997	1,117
	24"	3/4" x 1 1/2"	1,461	1,332	1,492
	36"	3/4" x 1 1/2"	1,796	1,668	1,868
	48"	3/4" x 1 1/2"	2,132	2,003	2,243
	60"	3/4" x 1 1/2"	2,467	2,338	2,619
	72"	3/4" x 1 1/2"	2,802	2,674	2,994
	84"	3/4" x 1 1/2"	3,138	3,009	3,370
	96"	3/4" x 1 1/2"	3,473	3,345	3,746

- Add \$6.50/in. over 96".
- MP (Mid Post) - Add \$68 each. (Recommended for maximum rigidity on long door pulls. See page 5 for guidelines.)
- Specify leather color.

NOTE: All long pulls include charge for leather between mounting posts up to a maximum of 72" of leather cover.



## Flush Leather Pulls

Straight Pulls - Flat Ends							
Part	Max OA	Dia.	3/605 4/606	10/612 10B/613	Stock PC 10BE	32D/630	32/629
<b>RM6300</b>	12"	1"	849	916	780	673	753
	24"	1"	1,266	1,368	1,186	1,058	1,185
	36"	1"	1,684	1,819	1,570	1,441	1,615
	48"	1"	2,102	2,270	1,955	1,826	2,046
	60"	1"	2,520	2,721	2,340	2,211	2,476
	72"	1"	2,937	3,172	2,724	2,596	2,907
	84"	1"	3,355	3,623	3,109	2,980	3,337
	96"	1"	3,773	4,075	3,493	3,364	3,768
<b>RM6310</b>	12"	1 1/4"	1,018	1,099	906	799	895
	24"	1 1/4"	1,453	1,568	1,315	1,186	1,328
	36"	1 1/4"	1,888	2,038	1,701	1,572	1,761
	48"	1 1/4"	2,322	2,508	2,087	1,959	2,194
	60"	1 1/4"	2,757	2,978	2,474	2,346	2,627
	72"	1 1/4"	3,192	3,448	2,861	2,733	3,061
	84"	1 1/4"	3,628	3,918	3,248	3,119	3,493
	96"	1 1/4"	4,062	4,387	3,635	3,506	3,927
<b>RM6320</b>	12"	1 1/2"	1,101	1,190	1,008	880	985
	24"	1 1/2"	1,548	1,671	1,406	1,278	1,431
	36"	1 1/2"	1,995	2,154	1,805	1,676	1,877
	48"	1 1/2"	2,441	2,636	2,204	2,075	2,324
	60"	1 1/2"	2,888	3,119	2,602	2,473	2,771
	72"	1 1/2"	3,334	3,602	3,000	2,871	3,217
	84"	1 1/2"	3,781	4,084	3,399	3,271	3,663
	96"	1 1/2"	4,228	4,567	3,797	3,669	4,109

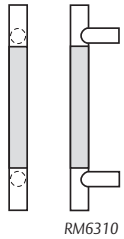

- Add \$6.50/in. over 96".
- Up to 96" available with mid-post (Recommended for maximum rigidity on long door pulls. See page 5 for guidelines.)
- Specify leather type and color.

Flush Leather Pulls (cont')

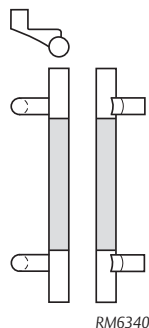

RM6330

Offset Pulls - Flat Ends							
Part	Max OA	Dia.	3/605 4/606	10/612 10B/613	Stock PC 10BE	32D/630	32/629
<b>RM6330</b>	12"	1"	886	957	817	710	796
	24"	1"	1,304	1,408	1,223	1,095	1,226
	36"	1"	1,721	1,860	1,608	1,479	1,657
	48"	1"	2,139	2,310	1,993	1,864	2,087
	60"	1"	2,557	2,761	2,377	2,248	2,518
	72"	1"	2,974	3,213	2,761	2,633	2,949
	84"	1"	3,392	3,664	3,146	3,018	3,380
	96"	1"	3,811	4,115	3,531	3,402	3,811
	<b>RM6340</b>	12"	1 1/4"	1,056	1,140	943	836
24"		1 1/4"	1,490	1,609	1,352	1,223	1,370
36"		1 1/4"	1,925	2,079	1,739	1,610	1,803
48"		1 1/4"	2,360	2,549	2,126	1,997	2,236
60"		1 1/4"	2,794	3,018	2,512	2,384	2,670
72"		1 1/4"	3,229	3,488	2,898	2,771	3,102
84"		1 1/4"	3,665	3,958	3,285	3,156	3,536
96"		1 1/4"	4,100	4,427	3,672	3,543	3,969
<b>RM6350</b>		12"	1 1/2"	1,139	1,229	1,045	917
	24"	1 1/2"	1,585	1,712	1,444	1,316	1,474
	36"	1 1/2"	2,032	2,194	1,843	1,714	1,920
	48"	1 1/2"	2,478	2,677	2,241	2,112	2,366
	60"	1 1/2"	2,926	3,160	2,640	2,511	2,812
	72"	1 1/2"	3,372	3,642	3,038	2,909	3,258
	84"	1 1/2"	3,819	4,125	3,436	3,308	3,704
	96"	1 1/2"	4,265	4,607	3,834	3,707	4,151

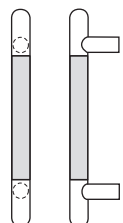

RM6314

Straight Pulls - Round Ends							
<b>RM6304</b>	12"	1"	934	1,009	828	721	807
	24"	1"	1,352	1,460	1,234	1,106	1,239
	36"	1"	1,770	1,912	1,618	1,490	1,669
	48"	1"	2,187	2,363	2,003	1,875	2,100
	60"	1"	2,605	2,813	2,388	2,259	2,530
	72"	1"	3,023	3,265	2,773	2,644	2,961
	84"	1"	3,440	3,716	3,156	3,028	3,391
	96"	1"	3,858	4,167	3,541	3,413	3,822
	<b>RM6314</b>	12"	1 1/4"	1,103	1,192	955	848
24"		1 1/4"	1,538	1,661	1,362	1,234	1,382
36"		1 1/4"	1,973	2,131	1,749	1,620	1,815
48"		1 1/4"	2,408	2,601	2,136	2,007	2,248
60"		1 1/4"	2,843	3,070	2,523	2,394	2,681
72"		1 1/4"	3,278	3,540	2,909	2,781	3,115
84"		1 1/4"	3,713	4,010	3,296	3,168	3,547
96"		1 1/4"	4,148	4,479	3,683	3,555	3,981
<b>RM6324</b>		12"	1 1/2"	1,187	1,282	1,057	928
	24"	1 1/2"	1,634	1,764	1,455	1,326	1,485
	36"	1 1/2"	2,080	2,246	1,853	1,724	1,931
	48"	1 1/2"	2,527	2,729	2,252	2,123	2,377
	60"	1 1/2"	2,973	3,212	2,650	2,522	2,825
	72"	1 1/2"	3,421	3,694	3,048	2,920	3,271
	84"	1 1/2"	3,867	4,177	3,448	3,319	3,717
	96"	1 1/2"	4,314	4,659	3,846	3,717	4,163

- Add \$6.50/in. over 96".
- Up to 96" available with mid-post (Recommended for maximum rigidity on long door pulls. See page 5 for guidelines.)
- Specify leather type and color.

**ASSA ABLOY**

Experience a safer  
and more open world

Flush Leather Pulls (cont')

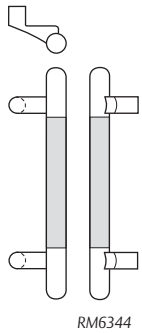

Offset Pulls - Round Ends							
Part	Max OA	Dia.	3/605 4/606	10/612 10B/613	Stock PC 10BE	32D/630	32/629
<b>RM6334</b>	12"	1"	971	1,049	865	758	850
	24"	1"	1,389	1,501	1,272	1,143	1,280
	36"	1"	1,808	1,952	1,656	1,528	1,711
	48"	1"	2,225	2,402	2,040	1,913	2,141
	60"	1"	2,643	2,854	2,425	2,296	2,572
	72"	1"	3,061	3,305	2,810	2,681	3,002
	84"	1"	3,478	3,756	3,194	3,066	3,434
	96"	1"	3,896	4,208	3,579	3,451	3,865
	<b>RM6344</b>	12"	1 1/4"	1,141	1,232	1,013	885
24"		1 1/4"	1,576	1,701	1,400	1,272	1,424
36"		1 1/4"	2,010	2,172	1,787	1,658	1,857
48"		1 1/4"	2,445	2,642	2,174	2,045	2,290
60"		1 1/4"	2,881	3,111	2,560	2,432	2,724
72"		1 1/4"	3,316	3,581	2,947	2,818	3,156
84"		1 1/4"	3,750	4,051	3,333	3,205	3,590
96"		1 1/4"	4,185	4,520	3,720	3,592	4,023
<b>RM6354</b>		12"	1 1/2"	1,224	1,322	1,094	965
	24"	1 1/2"	1,671	1,804	1,492	1,363	1,528
	36"	1 1/2"	2,117	2,287	1,891	1,762	1,974
	48"	1 1/2"	2,565	2,770	2,289	2,161	2,420
	60"	1 1/2"	3,011	3,252	2,687	2,559	2,866
	72"	1 1/2"	3,458	3,735	3,086	2,958	3,312
	84"	1 1/2"	3,904	4,217	3,485	3,356	3,759
	96"	1 1/2"	4,351	4,700	3,883	3,754	4,205

- Add \$6.50/in. over 96".
- Up to 96" available with mid-post (Recommended for maximum rigidity on long door pulls. See page 5 for guidelines.)
- Specify leather type and color.

Upholstery Leather GeoMetek - Narrow Profile Pulls

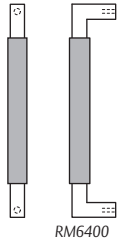

RM6400



RM6410

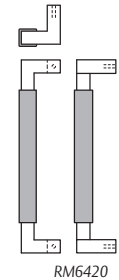

RM6420

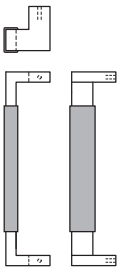

RM6430

Straight Square End Pulls					
Part	CTC	Grip Size	Stock PC 10BE	32D/630	32/629
<b>RM6400</b>	12"	3/4" x 3/4"	632	522	584
	24"	3/4" x 3/4"	1,015	883	989
	36"	3/4" x 3/4"	1,376	1,244	1,393
	48"	3/4" x 3/4"	1,737	1,605	1,797
<b>RM6440</b>	12"	1 1/4" x 1 1/4"	733	623	698
	24"	1 1/4" x 1 1/4"	1,212	1,080	1,208
	36"	1 1/4" x 1 1/4"	1,667	1,535	1,719
	48"	1 1/4" x 1 1/4"	2,123	1,991	2,230
Straight Rectangular End Pulls					
<b>RM6410</b>	12"	3/4" x 1 1/2"	739	629	704
	24"	3/4" x 1 1/2"	1,065	932	1,044
	36"	3/4" x 1 1/2"	1,369	1,236	1,384
	48"	3/4" x 1 1/2"	1,671	1,539	1,724
	60"	3/4" x 1 1/2"	1,975	1,843	2,063
	72"	3/4" x 1 1/2"	2,279	2,146	2,403
	84"	3/4" x 1 1/2"	2,582	2,449	2,744
	96"	3/4" x 1 1/2"	2,885	2,753	3,084
Offset Square End Pulls					
<b>RM6420</b>	12"	3/4" x 3/4"	671	561	628
	24"	3/4" x 3/4"	1,054	921	1,032
	36"	3/4" x 3/4"	1,414	1,282	1,436
	48"	3/4" x 3/4"	1,775	1,643	1,840
Offset Rectangular End Pulls					
<b>RM6430</b>	12"	3/4" x 1 1/2"	778	668	748
	24"	3/4" x 1 1/2"	1,103	971	1,088
	36"	3/4" x 1 1/2"	1,407	1,274	1,427
	48"	3/4" x 1 1/2"	1,710	1,578	1,767
	60"	3/4" x 1 1/2"	2,013	1,881	2,107
	72"	3/4" x 1 1/2"	2,317	2,185	2,447
	84"	3/4" x 1 1/2"	2,621	2,488	2,786
	96"	3/4" x 1 1/2"	2,923	2,791	3,126

Leather - Small Pulls for Cabinets, Casework & Closet Doors

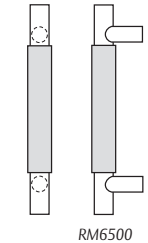

RM6500

Straight Surface Wrapped - Flat Ends							
Part	Max OA	Dia.	3/605 4/606	10/612 10B/613	Stock PC 10BE	32D/630	32/629
RM6500-4	5 7/8"	1/2"	186	201	198	144	153
RM6500-5	6 7/8"	1/2"	199	214	208	154	165
RM6510-5	6 7/8"	5/8"	228	246	237	183	198
RM6510-6	7 7/8"	5/8"	256	277	263	210	224

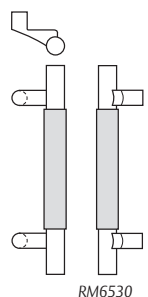

RM6530

Offset Surface Wrapped - Flat Ends							
RM6530-5	7"	5/8"			307	235	252
RM6530-6	8"	5/8"			334	260	279

Straight Surface Wrapped - Round Ends							
RM6540-4	5 7/8"	1/2"	205	222	215	162	173
RM6540-5	6 7/8"	1/2"	219	238	228	175	186
RM6550-5	7"	5/8"	249	269	256	203	216
RM6550-6	8"	5/8"	276	297	297	227	243

Offset Surface Wrapped - Round Ends							
RM6570-5	7"	5/8"			328	254	271
RM6570-6	8"	5/8"			356	280	298

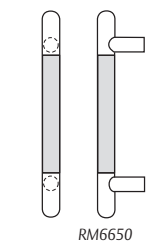

RM6650

Straight Flush Wrapped - Flat Ends							
RM6610-5	6 7/8"	5/8"	256	277	248	193	207
RM6610-6	7 7/8"	5/8"	288	312	311	225	240

Offset Flush Wrapped - Flat Ends							
RM6630-5	6 7/8"	5/8"			320	235	252
RM6630-6	7 7/8"	5/8"			354	268	286

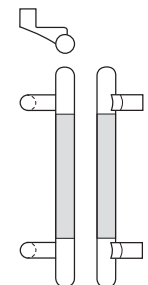

RM6670

Straight Flush Wrapped - Round Ends							
RM6650-5	6 7/8"	5/8"	270	290	260	207	220
RM6650-6	7 7/8"	5/8"	303	328	323	238	255

Offset Flush Wrapped - Round Ends							
RM6670-5	6 7/8"	5/8"			334	249	265
RM6670-6	7 7/8"	5/8"			365	280	298

Straight Full Wrapped - Flat Ends							
RM6700-4	5 7/8"	1/2"	213	229	229	185	200
RM6700-5	6 7/8"	1/2"	240	258	258	210	224
RM6710-5	6 7/8"	5/8"	261	283	283	230	248
RM6710-6	7 7/8"	5/8"	293	316	316	260	279

Offset Full Wrapped - Flat Ends							
RM6730-5	6 7/8"	5/8"			331	272	290
RM6730-6	7 7/8"	5/8"			363	302	322

- Any size made to order.
- Specify leather type and color.

NeoCylinder - with or without GripZone

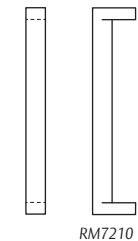

Straight Pulls without GripZone					
Part	CTC	Dia.	Stock PC 10BE	32D/630	32/629
RM7210	12"	1 1/4"	424	321	359
	24"	1 1/4"	480	375	421
	36"	1 1/4"	535	430	481

Offset Pulls without GripZone					
Part	CTC	Dia.	Stock PC 10BE	32D/630	32/629
RM7220	12"	1 1/4"	466	363	406
	24"	1 1/4"	522	417	467
	36"	1 1/4"	579	472	529

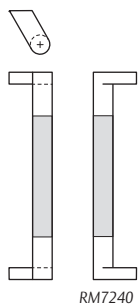

Straight Pulls with GripZone					
Part	CTC	Dia.	Stock PC 10BE	32D/630	32/629
RM7230	12"	1 1/4"			478
	24"	1 1/4"			540
	36"	1 1/4"			602

Offset Pulls with GripZone					
Part	CTC	Dia.	Stock PC 10BE	32D/630	32/629
RM7240	12"	1 1/4"			519
	24"	1 1/4"			582
	36"	1 1/4"			643

Push Bar without GripZone					
Part	CTC	Dia.	Stock PC 10BE	32D/630	32/629
RM7212	Up to 36"	1 1/4"	535	430	481

Push Bar with GripZone					
Part	CTC	Dia.	Stock PC 10BE	32D/630	32/629
RM7232	Up to 36"	1 1/4"			602

• Add \$6.50/in. over 36".

NeoMitre - with or without GripZone

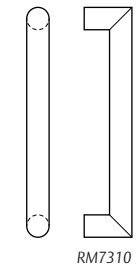

Straight Pulls without GripZone					
Part	CTC	Dia.	Stock PC 10BE	32D/630	32/629
RM7300	12"	1"	448	347	388
	24"	1"	525	422	472
	36"	1"	624	496	555
RM7310	12"	1 1/4"	603	475	532
	24"	1 1/4"	648	518	580
	36"	1 1/4"	691	561	629
RM7320	12"	1 1/2"	693	563	631
	24"	1 1/2"	739	608	682
	36"	1 1/2"	784	653	730

Offset Pulls without GripZone					
Part	CTC	Dia.	Stock PC 10BE	32D/630	32/629
RM7330	12"	1"	490	388	434
	24"	1"	566	462	517
	36"	1"	667	537	602
RM7340	12"	1 1/4"	646	515	578
	24"	1 1/4"	689	559	625
	36"	1 1/4"	734	603	675
RM7350	12"	1 1/2"	736	605	677
	24"	1 1/2"	781	650	727
	36"	1 1/2"	826	693	776

Push Bars without GripZone					
Part	CTC	Dia.	Stock PC 10BE	32D/630	32/629
RM7302	Up to 36"	1"	624	496	555
RM7312	Up to 36"	1 1/4"	691	561	629
RM7322	Up to 36"	1 1/2"	784	653	730

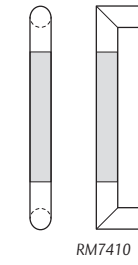

Straight Pulls with GripZone			
Part	CTC	Dia.	32/629
RM7400	12"	1"	505
	24"	1"	588
	36"	1"	672
RM7410	12"	1 1/4"	649
	24"	1 1/4"	697
	36"	1 1/4"	745
RM7420	12"	1 1/2"	748
	24"	1 1/2"	798
	36"	1 1/2"	848

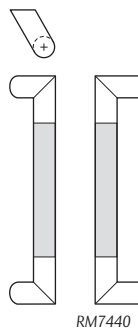

Offset Pulls with GripZone			
Part	CTC	Dia.	32/629
RM7430	12"	1"	550
	24"	1"	634
	36"	1"	719
RM7440	12"	1 1/4"	694
	24"	1 1/4"	743
	36"	1 1/4"	792
RM7450	12"	1 1/2"	794
	24"	1 1/2"	844
	36"	1 1/2"	895

Push Bars with GripZone			
Part	CTC	Dia.	32/629
RM7402	Up to 36"	1"	672
RM7412	Up to 36"	1 1/4"	745
RM7422	Up to 36"	1 1/2"	848

• Add \$6.50/in. over 36".

NOTE: Post location on push bars can be located 1/8" from end for narrow & medium stile doors and 1" from end for flush and wide stile doors.

### GeoMetek - Hex Pulls

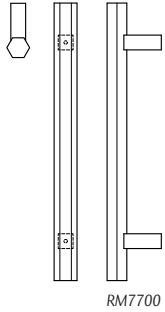

Flat End - Square Post					
Part	Max OA	Grip	Stock PC 10BE	32D/630	32/629
<b>RM7700</b>	12"	1"	516	407	456
	24"	1"	586	453	507
	36"	1"	635	499	558
	48"	1"	683	544	610
	60"	1"	730	590	660
	72"	1"	778	635	712
	84"	1"	826	680	762
	96"	1"	873	727	814

• Add \$9.70/in. over 96".

### GeoMetek - Diamond Pulls

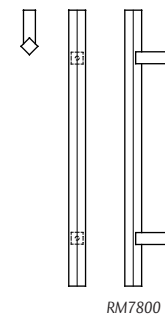

Flat End - Square Post					
Part	Max OA	Grip	Stock PC 10BE	32D/630	32/629
<b>RM7800</b>	12"	3/4" x 3/4"	438	327	365
	24"	3/4" x 3/4"	484	372	417
	36"	3/4" x 3/4"	532	418	467
	48"	3/4" x 3/4"	603	462	518

Flat End - Diamond Post					
Part	Max OA	Grip	Stock PC 10BE	32D/630	32/629
<b>RM7805</b>	12"	3/4" x 3/4"	466	354	397
	24"	3/4" x 3/4"	513	400	447
	36"	3/4" x 3/4"	562	445	500
	48"	3/4" x 3/4"	633	491	549

Diamond End - Square Post					
Part	Max OA	Grip	Stock PC 10BE	32D/630	32/629
<b>RM7810</b>	12"	3/4" x 3/4"	607	466	539
	24"	3/4" x 3/4"	655	512	573
	36"	3/4" x 3/4"	704	558	626
	48"	3/4" x 3/4"	752	604	675

Diamond End - Diamond Post					
Part	Max OA	Grip	Stock PC 10BE	32D/630	32/629
<b>RM7815</b>	12"	3/4" x 3/4"	638	496	554
	24"	3/4" x 3/4"	685	540	606
	36"	3/4" x 3/4"	734	587	657
	48"	3/4" x 3/4"	780	631	707

• Add \$9.70/in. over 48".

### GeoMetek - Narrow Profile Pulls

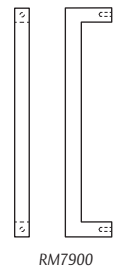

Straight Square End Pulls					
Part	CTC	Grip Size	Stock PC 10BE	32D/630	32/629
<b>RM7900</b>	12"	3/4" x 3/4"	289	217	243
	24"	3/4" x 3/4"	373	263	294
	36"	3/4" x 3/4"	422	309	345
	48"	3/4" x 3/4"	471	355	398
<b>RM7907</b>	12"	1" x 1"	318	239	268
	24"	1" x 1"	410	289	323
	36"	1" x 1"	464	339	380
	48"	1" x 1"	517	391	438
<b>RM7940</b>	12"	1 1/4" x 1 1/4"	386	275	309
	24"	1 1/4" x 1 1/4"	442	328	366
	36"	1 1/4" x 1 1/4"	497	380	425
	48"	1 1/4" x 1 1/4"	551	432	482

• Add \$9.70/in. over 48".

**ASSA ABLOY**

Experience a safer  
and more open world

GeoMetek - Narrow Profile Pulls (cont')

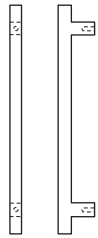

RM7902

Straight Square Bridge Pulls					
Part	Max OA	Grip Size	Stock PC/10BE	32D/630	32/629
RM7902	12"	3/4" x 3/4"	377	268	299
	24"	3/4" x 3/4"	425	312	350
	36"	3/4" x 3/4"	473	358	401
	48"	3/4" x 3/4"	520	402	450
RM7917	12"	1" x 1"	416	295	331
	24"	1" x 1"	467	343	384
	36"	1" x 1"	520	394	441
	48"	1" x 1"	573	442	496

Straight Rectangular End Pulls					
Part	CTC	Grip Size	Stock PC/10BE	32D/630	32/629
RM7910	12"	3/4" x 1 1/2"	360	251	280
	24"	3/4" x 1 1/2"	557	436	488
	36"	3/4" x 1 1/2"	777	622	696
	48"	3/4" x 1 1/2"	970	806	903

Straight Rectangular Bridge Pulls					
Part	Max OA	Grip Size	Stock PC/10BE	32D/630	32/629
RM7912	12"	3/4" x 1 1/2"	410	298	334
	24"	3/4" x 1 1/2"	631	483	542
	36"	3/4" x 1 1/2"	827	669	749
	48"	3/4" x 1 1/2"	1,023	854	956

Offset Pulls					
Part	CTC	Grip Size	Stock PC/10BE	32D/630	32/629
RM7920	12"	3/4" x 3/4"	363	253	282
	24"	3/4" x 3/4"	407	295	331
	36"	3/4" x 3/4"	453	339	379
	48"	3/4" x 3/4"	498	381	426
RM7927	12"	1" x 1"	400	278	312
	24"	1" x 1"	448	324	363
	36"	1" x 1"	498	373	418
	48"	1" x 1"	549	419	469
RM7930	12"	3/4" x 1 1/2"	408	296	332
	24"	3/4" x 1 1/2"	619	473	529
	36"	3/4" x 1 1/2"	807	650	728
	48"	3/4" x 1 1/2"	993	825	925

Offset Square Bridge Pull					
Part	Max OA	Grip Size	Stock PC/10BE	32D/630	32/629
RM7925	12"	3/4" x 3/4"	412	305	341
	24"	3/4" x 3/4"	459	349	391
	36"	3/4" x 3/4"	508	395	442
	48"	3/4" x 3/4"	577	439	491
RM7937	12"	1" x 1"	432	320	359
	24"	1" x 1"	482	366	411
	36"	1" x 1"	533	415	464
	48"	1" x 1"	605	461	517

Offset Rectangular Bridge Pull					
Part	CTC	Grip Size	Stock PC/10BE	32D/630	32/629
RM7935	12"	3/4" x 1 1/2"	444	335	375
	24"	3/4" x 1 1/2"	663	520	582
	36"	3/4" x 1 1/2"	860	706	791
	48"	3/4" x 1 1/2"	1,077	890	998

Straight Rectangular End Stepped Post Pull					
Part	CTC	Grip Size	Stock PC/10BE	32D/630	32/629
RM7960	12"	3/4" x 3/4"	410	298	334
	24"	3/4" x 3/4"	465	350	392
	36"	3/4" x 3/4"	518	400	447
	48"	3/4" x 3/4"	597	452	506

Straight Rectangular End Stepped Post Cast Pull					
Part	CTC	Grip Size	3/605 4/606	10/612 10B/613	15/619
RM7960	12"	3/4" x 3/4"	396	407	434

• Add \$9.70/in. over 48".

**ASSA ABLOY**

Experience a safer  
and more open world



## Locking Door Pulls

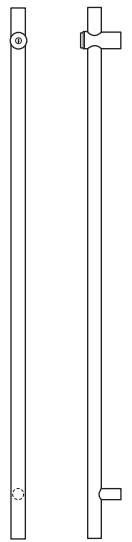

LP3301DBD

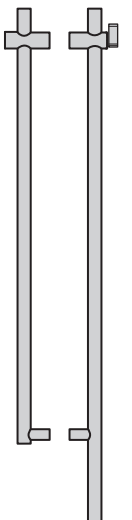

LP3305DBD

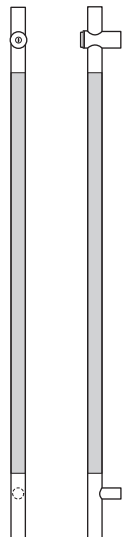

LP3401DBD

PostMount - Round						
Part	Description	3/605 4/606	Stock PC 10BE	10B/613 10BL/614	32D/630	32/629
LP3301DBD	Half Height Pull - Bolts Down	1,895	1,476	2,047	1,090	1,219
LP3301DBU	Half Height Pull - Bolts Up	2,079	1,574	2,246	1,175	1,317
LP3301FHD	Full Height Pull - Bolts Down	2,300	1,668	2,487	1,259	1,411
LP3301FHU	Full Height Pull - Bolts Up	2,524	1,779	2,726	1,359	1,523
LP3301FHB	Full Height Pull - Bolts Up and Down	2,779	2,046	3,000	1,596	1,789
Horizontal Push/Pull Bar Option - Half Height – Bolts Down (DBD)						
LP3301DBDBEPB	Bent End Both Sides	2,521	1,880	2,722	1,449	1,622
LP3301DBDBEPT	Bent End Thumbturn Side - Mating Side Vertical	2,208	1,679	2,385	1,270	1,422
LP3301DBDBEPC	Bent End Cylinder Side - Mating Side Vertical	2,208	1,679	2,385	1,270	1,422
LP3301DBDPMPB	Post Mount Both Sides	2,765	2,007	2,988	1,562	1,750
LP3301DBDPMPT	Post Mount Thumbturn Side - Mating Side Vertical	2,423	1,790	2,616	1,368	1,533
LP3301DBDPMPC	Post Mount Cylinder Side - Mating Side Vertical	2,423	1,790	2,616	1,368	1,533
Horizontal Push/Pull Bar Option - Half Height – Bolts Up (DBU)						
LP3301DBUBEPB	Bent End Both Sides	2,521	1,880	2,722	1,449	1,622
LP3301DBUBEPT	Bent End Thumbturn Side - Mating Side Vertical	2,208	1,679	2,385	1,270	1,422
LP3301DBUBEPC	Bent End Cylinder Side - Mating Side Vertical	2,208	1,679	2,385	1,270	1,422
LP3301DBUPMPB	Post Mount Both Sides	2,765	2,007	2,988	1,562	1,750
LP3301DBUPMPT	Post Mount Thumbturn Side - Mating Side Vertical	2,423	1,790	2,616	1,368	1,533
LP3301DBUPMPC	Post Mount Cylinder Side - Mating Side Vertical	2,423	1,790	2,616	1,368	1,533
Half Height Locking Pull						
LP3305DBD	Round Half Height Pull - Bolts Down / Minimum of 10" Clearance on Keyside of Pull	1,936	1,517	2,088	1,132	1,260
NeoTek with GripZone - Round						
Part	Description	3/605	32/629			
LP3401DBD	Half Height Pull - Bolts Down	2,031	1,309			
LP3401DBU	Half Height Pull - Bolts Up	2,228	1,411			
LP3401FHD	Full Height Pull - Bolts Down	2,436	1,510			
LP3401FHU	Full Height Pull - Bolts Up	2,673	1,629			
LP3401FHB	Full Height Pull - Bolts Up and Down	2,929	1,865			
Horizontal Push/Pull Bar Option - Half Height – Bolts Down (DBD)						
LP3401DBDBEPB	Bent End Both Sides	2,701	1,741			
LP3401DBDBEPT	Bent End Thumbturn Side - Mating Side Vertical	2,366	1,525			
LP3401DBDBEPC	Bent End Cylinder Side - Mating Side Vertical	2,366	1,525			
LP3401DBDPMPB	Post Mount Both Sides	2,701	1,741			
LP3401DBDPMPT	Post Mount Thumbturn Side - Mating Side Vertical	2,366	1,525			
LP3401DBDPMPC	Post Mount Cylinder Side - Mating Side Vertical	2,366	1,525			
Horizontal Push/Pull Bar Option - Half Height – Bolts Up (DBU)						
LP3401DBUBEPB	Bent End Both Sides	2,964	1,877			
LP3401DBUBEPT	Bent End Thumbturn Side - Mating Side Vertical	2,596	1,644			
LP3401DBUBEPC	Bent End Cylinder Side - Mating Side Vertical	2,596	1,644			
LP3401DBUPMPB	Post Mount Both Sides	2,964	1,877			
LP3401DBUPMPT	Post Mount Thumbturn Side - Mating Side Vertical	2,596	1,644			
LP3401DBUPMPC	Post Mount Cylinder Side - Mating Side Vertical	2,596	1,644			

- DBD and DBU priced as 51" overall. Add \$13/in. over 96" long for full height or 51" long for half height.
- Horizontal Push/Pull Option, add \$13/in. over 36".

NOTE: New square Locking Pulls only available in US10BE, US32, and US32D.

Order form available when ordering LP3301 AND LP3305.

LP3305DBD has a minimum of 10" clearance on the keyside to reduce interference with mobility devices. Product comes standard with ADA thumbturn.

**ASSA ABLOY**

Experience a safer  
and more open world

Locking Door Pulls (con't)

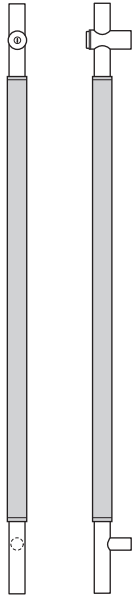

LP6061DBD

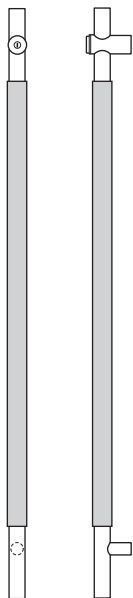

LP6161DBD

English Bridle Leather Wrapped - Round						
Part	Description	3/605 4/606	Stock PC 10BE	10B/613 10BL/614	32D/630	32/629
LP6061DBD	Half Height Pull - Bolts Down	5,277	4,437	5,699	4,309	4,826
LP6061DBU	Half Height Pull - Bolts Up	5,461	4,534	5,898	4,405	4,912
LP6061FHD	Full Height Pull - Bolts Down	6,719	5,712	7,256	5,583	6,252
LP6061FHU	Full Height Pull - Bolts Up	6,942	5,823	7,496	5,694	6,352
LP6061FHB	Full Height Pull - Bolts Up and Down	7,198	6,090	7,771	5,961	6,589
Horizontal Push/Pull Bar Option - Half Height – Bolts Down (DBD)						
LP6061DBDBECP*	Bent End Both Sides	6,855	5,289	7,403	5,162	5,739
LP6061DBDBEPT*	Bent End Thumbturn Side - Mating Side Vertical	6,065	4,863	6,551	4,735	5,282
LP6061DBDBEPC*	Bent End Cylinder Side - Mating Side Vertical	6,065	4,863	6,551	4,735	5,282
LP6061DBDPMPB*	Post Mount Both Sides	6,855	5,289	7,403	5,162	5,739
LP6061DBDPMPT*	Post Mount Thumbturn Side - Mating Side Vertical	6,065	4,863	6,551	4,735	5,282
LP6061DBDPMPC*	Post Mount Cylinder Side - Mating Side Vertical	6,065	4,863	6,551	4,735	5,282
Horizontal Push/Pull Bar Option - Half Height – Bolts Up (DBU)						
LP6061DBUBECP*	Bent End Both Sides	7,039	5,387	7,602	5,258	5,824
LP6061DBUBEPT*	Bent End Thumbturn Side - Mating Side Vertical	6,249	4,961	6,751	4,832	5,367
LP6061DBUBEPC*	Bent End Cylinder Side - Mating Side Vertical	6,249	4,961	6,751	4,832	5,367
LP6061DBUPMPB*	Post Mount Both Sides	7,039	5,387	7,602	5,258	5,824
LP6061DBUPMPT*	Post Mount Thumbturn Side - Mating Side Vertical	6,249	4,961	6,751	4,832	5,367
LP6061DBUPMPC*	Post Mount Cylinder Side - Mating Side Vertical	6,249	4,961	6,751	4,832	5,367
PostMount Upholstery Leather Wrapped - Round						
LP6161DBD	Half Height Pull - Bolts Down	5,174	4,347	5,587	4,218	4,725
LP6161DBU	Half Height Pull - Bolts Up	5,358	4,444	5,787	4,316	4,811
LP6161FHD	Full Height Pull - Bolts Down	6,382	5,376	6,893	5,247	5,877
LP6161FHU	Full Height Pull - Bolts Up	6,605	5,487	7,133	5,358	5,976
LP6161FHB	Full Height Pull - Bolts Up and Down	6,860	5,753	7,407	5,625	6,213
Horizontal Push/Pull Bar Option - Half Height – Bolts Down (DBD)						
LP6161DBDBECP*	Bent End Both Sides	6,685	5,186	7,220	5,059	5,624
LP6161DBDBEPT*	Bent End Thumbturn Side - Mating Side Vertical	5,929	4,768	6,403	4,669	5,146
LP6161DBDBEPC*	Bent End Cylinder Side - Mating Side Vertical	5,929	4,768	6,403	4,669	5,146
LP6161DBDPMPB*	Post Mount Both Sides	6,685	5,186	7,220	5,059	5,624
LP6161DBDPMPT*	Post Mount Thumbturn Side - Mating Side Vertical	5,929	4,768	6,403	4,669	5,146
LP6161DBDPMPC*	Post Mount Cylinder Side - Mating Side Vertical	5,929	4,768	6,403	4,669	5,146
Horizontal Push/Pull Bar Option - Half Height – Bolts Up (DBU)						
LP6161DBUBECP*	Bent End Both Sides	6,869	5,284	7,419	5,155	5,710
LP6161DBUBEPT*	Bent End Thumbturn Side - Mating Side Vertical	6,113	4,865	6,603	4,765	5,232
LP6161DBUBEPC*	Bent End Cylinder Side - Mating Side Vertical	6,113	4,865	6,603	4,765	5,232
LP6161DBUPMPB*	Post Mount Both Sides	6,869	5,284	7,419	5,155	5,710
LP6161DBUPMPT*	Post Mount Thumbturn Side - Mating Side Vertical	6,113	4,865	6,603	4,765	5,232
LP6161DBUPMPC*	Post Mount Cylinder Side - Mating Side Vertical	6,113	4,865	6,603	4,765	5,232

• DBD and DBU priced as 51" overall. Add 5/16" over 96" long for full height or 51" long for half height.

\* Price includes up to 42" of English Bridle Leather on vertical.

Other options available upon request.

NOTE: New square Locking Pulls only available in US10BE, US32, and US32D.

### Locking Door Pulls (con't)

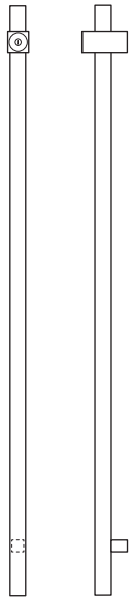

GeoMetek Upholstery Leather Wrapped - Square						
Part	Description	3/605 4/606	Stock PC 10BE	10B/613 10BL/614	32D/630	32/629
LP6440DBD	Half Height Pull - Bolts Down		4,568		4,439	4,971
LP6440DBU	Half Height Pull - Bolts Up		4,665		4,536	5,058
LP6440FHD	Full Height Pull - Bolts Down		5,596		5,467	6,122
LP6440FHU	Full Height Pull - Bolts Up		5,708		5,579	6,222
LP6440FHB	Full Height Pull - Bolts Up and Down		5,974		5,846	6,459
GeoMetek - Square						
LP7901DBD	Half Height Pull - Bolts Down		1,564		1,307	1,398
LP7901DBU	Half Height Pull - Bolts Up		1,666		1,408	1,507
LP7901FHD	Full Height Pull - Bolts Down		1,770		1,512	1,618
LP7901FHU	Full Height Pull - Bolts Up		1,888		1,631	1,744
LP7901FHB	Full Height Pull - Bolts Up and Down		2,172		1,915	2,048
MegaTek Dummy Pull - Round						
DP3301DBD	Half Height Pull - Bolts Down	1,487	1,129	1,607	872	932
DP3301DBU	Half Height Pull - Bolts Up	1,487	1,129	1,607	872	932
DP3301FHD	Full Height Pull - Bolts Down	2,031	1,392	2,193	1,135	1,214
DP3301FHU	Full Height Pull - Bolts Up	2,031	1,392	2,193	1,135	1,214
NeoTek with GripZone Dummy Pull - Round						
DP3401DBD	Half Height Pull - Bolts Down	1,593				1,046
DP3401DBU	Half Height Pull - Bolts Up	1,593				1,046
DP3401FHD	Full Height Pull - Bolts Down	2,150				1,359
DP3401FHU	Full Height Pull - Bolts Up	2,150				1,359
GeoMetek Dummy Pull - Square						
DP7901DBD	Half Height Pull - Bolts Down		1,301		1,044	1,117
DP7901DBU	Half Height Pull - Bolts Up		1,301		1,044	1,117
DP7901FHD	Full Height Pull - Bolts Down		1,618		1,361	1,457
DP7901FHU	Full Height Pull - Bolts Up		1,618		1,361	1,457

• DBD and DBU priced as 51" overall. Add \$13/in. over 96" long for full height or 51" long for half height.

\* Price includes up to 42" of Upholstry Leather on vertical. Other options available upon request.

NOTE: New Square Locking Pulls only available in US10BE, US32, and US32D.

### Locking Door Pull Accessories

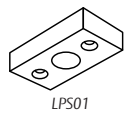

LPS01

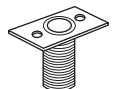

570

LPS01	Top Strike - 3/4" x 1 1/2" x 3"		42	41	72	80
LPS02	Top Strike - w/Rubber Stop - 3/4" x 2 1/2" x 3"		42	41	72	80
LPS03	Top Strike - Stainless Steel - .050" x 1 1/8" x 2 1/4"		42		33	37
LPS04	Transom Strike - 1 1/4"D x 4"H		135		98	109
LPS05	Transom Strike - 1 1/4"SQ x 4 1/2"H		157		113	127
LPS06	Mortised Header Strike 2" Dia.		192		150	173
Part	Description	3/605 4/606	10/612 10BL/614	Stock PC 10BE	26/625 26D/626	15/619
570	Dust Proof Strike	Refer to Accessories Price Book for Pricing				
Part	Description	3/605 4/606	10/612 10BL/614	Stock PC 10BE	26/625 26D/626	32D/630
RM850	Floor Mounted Stop 1 1/2" Projection	45	49	48	41	38
RM851	Floor Mounted Stop 2 1/2" Projection	57	63	61	57	50
Part	Description	3/605 4/606	Stock PC 10BE	32D/630		
ADA (suffix)	ADA Large Thumbturn - 1 13/16" Projection		42	42	41	

NOTE: Thumbturn design differs between the round and square versions.

**ASSA ABLOY**

Experience a safer  
and more open world

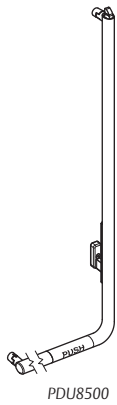

Storefront Panic Device

Part	Latches	Mating Handle Shape	Mating Handle Length	Stock PC 10BE	32D/630	32/629	32/32D
PDU8500	Up	None	None	5,550	4,826	5,550	5,646
PDU8500-1	Up	L-Shape	Full	7,063	6,142	7,063	7,186
PDU8500-2	Up	L-Shape	Half	6,895	5,996	6,895	7,014
PDU8500-3	Up	Vertical	Full	6,895	5,996	6,895	7,014
PDU8500-4	Up	Vertical	Half	6,363	5,534	6,363	6,475
PDU8500-5	Up	Vertical	Short	6,109	5,312	6,109	6,214
PDU8500-6	Up	Horizontal	Full	6,109	5,312	6,109	6,214

If Vertical CTC is > 70 7/8" or Horizontal CTC is > 33 3/4" there is a \$360 add on price.  
 Order Form available for PDU8500 configurations.



Strikes

Panic Strike Kits (Strike, Adapter Plate, Cover) For stiles 5" or greater.							
Part	Description	Keeper Length	Voltage	Mode	Stock PC 10BE	32D/630	32/629
ESK-SGL-24D	Single Door	3/4"	24V DC	Fail Secure	1,261	1,067	1,227
ESK-DBL-24D	Double Door	3/4"	24V DC	Fail Secure	2,522	2,133	2,454
ESK-SGL-12D	Single Door	3/4"	12V DC	Fail Secure	1,261	1,067	1,227
ESK-DBL-12D	Double Door	3/4"	12V DC	Fail Secure	2,522	2,133	2,454
ESK-SGL-24D-FS	Single Door	3/4"	24V DC	Fail Safe	1,261	1,067	1,227
ESK-DBL-24D-FS	Double Door	3/4"	24V DC	Fail Safe	2,522	2,133	2,454
ESK-SGL-12D-FS	Single Door	3/4"	12V DC	Fail Safe	1,261	1,067	1,227
ESK-DBL-12D-FS	Double Door	3/4"	12V DC	Fail Safe	2,522	2,133	2,454
MSK-SGL	Single Door				221	187	215
MSK-DBL	Double Door				315	267	307
SL100	Security Latch Adapter	Single Manual Strike			2,355	2,048	2,355
		Double Manual Strike			4,709	4,095	4,709
AC-Rectifier	AC Converter for Electric Strike				78		
ES-SmartpacIII	Power Controller				120		
†LCBMA	Door Monitoring				160		
Medium Stile Panic Strike Kits (Strike, Adapter Plate, Cover) For stiles 3 1/2" and less than 5".							
ESK-MS-SGL-24D	Single Door	3/4"	24V DC	Fail Secure	1,450	1,227	1,411
ESK-MS-DBL-24D	Double Door	3/4"	24V DC	Fail Secure	2,900	2,453	2,822
ESK-MS-SGL-12D	Single Door	3/4"	12V DC	Fail Secure	1,450	1,227	1,411
ESK-MS-DBL-12D	Double Door	3/4"	12V DC	Fail Secure	2,900	2,453	2,822
ESK-MS-SGL-24D-FS	Single Door	3/4"	24V DC	Fail Safe	1,450	1,227	1,411
ESK-MS-DBL-24D-FS	Double Door	3/4"	24V DC	Fail Safe	2,900	2,453	2,822
ESK-MS-SGL-12D-FS	Single Door	3/4"	12V DC	Fail Safe	1,450	1,227	1,411
ESK-MS-DBL-12D-FS	Double Door	3/4"	12V DC	Fail Safe	2,900	2,453	2,822
AC-Rectifier	AC Converter for Electric Strike				78		
ES-SmartpacIII	Power Controller				120		
310-1 Electric Strikes Body Only							
Part	Description	Keeper Length	Voltage	Mode	Price		
ES-310-1-3/4-24D	Electric Strike	3/4"	24V DC	Fail Secure	646		
ES-310-1-3/4-12D	Electric Strike	3/4"	12V DC	Fail Secure	646		
ES-310-1-3/4-24D-FS	Electric Strike	3/4"	24V DC	Fail Safe	646		
ES-310-1-3/4-12D-FS	Electric Strike	3/4"	12V DC	Fail Safe	646		
ES-MS-310-1-1-3/4-24D	Medium Stile Double Electric Strike	3/4"	24V DC	Fail Secure	1,292		
ES-MS-310-1-1-3/4-12D	Medium Stile Double Electric Strike	3/4"	12V DC	Fail Secure	1,292		
ES-MS-310-1-1-3/4-24D-FS	Medium Stile Double Electric Strike	3/4"	24V DC	Fail Safe	1,292		
ES-MS-310-1-1-3/4-12D-FS	Medium Stile Double Electric Strike	3/4"	12V DC	Fail Safe	1,292		

†Note: LCBMA is not available on 310-1-1 models or medium stiles.  
 Note: Medium stiles are 3 1/2" - 5". Wide stiles are over 5".

## Architectural Finishes

Most of Rockwood's products are available in all of the following architectural finishes. The catalog indicates exceptions. This finish list is grouped by base metal.

Base Metal	Description	Price Book Code	Rockwood Code	BHMA Code
Aluminum	Satin	27	US27	627
Aluminum	Clear Anodized	28	US28	628
Aluminum	Light Bronze Anodized	311	311	—
Aluminum	Medium Bronze Anodized	312	312	—
Aluminum	Dark Bronze Anodized	313	313	710
Aluminum	Extra Dark Bronze Anodized	314	314	—
Aluminum	Black Anodized	315	315	711
Aluminum	White Powder Coat	WPC	WPC	—
Aluminum	Red Powder Coat	RPC	RPC	—
Aluminum	Black Powder Coat	BPC	BPC	—
Brass	Polished Clear Coated	3	US3	605
Brass	Polished No Coating	3NL	US3NL	—
Brass	Satin Clear Coated	4	US4	606
Brass	Satin Oxidized Relieved	5	US5	609
Brass	Satin Nickel Plated Clear Coated	15	US15	619
Brass	Satin Nickel Blackened Relieved Clear Coated	15A	US15A	620
Brass	Flat Black Powder Coated	19	US19	622
Brass	Polished Chrome Plated	26	US26	625
Brass	Satin Chrome Plated	26D	US26D	626
Bronze*	Polished Clear Coated	9	US9	611
Bronze*	Satin Clear Coated	10	US10	612
Bronze*	Satin Black Oxidized Oil Rubbed	10A	US10A	722
Bronze*	Satin Oxidized Oil Rubbed	10B	US10B	613
Bronze*	Satin Oxidized Clear Coated	10BL	US10BL	614
Bronze*	Dark Oxidized Statuary Clear Coated	20A	US20A	624
Stainless Steel	Polished	32	US32	629
Stainless Steel	Satin	32D	US32D	630
<b>Special Finishes</b> (see descriptions)				
Stainless Steel	Satin MicroShield® Coated	32DMS***	US32DMS***	—
Stainless Steel	Polished 316 Alloy	32316***	US32316***	—
Stainless Steel	Satin 316 Alloy	32D316***	US32D316***	—
	Dark Oxidized Satin Bronze, Equivalent	10BE	US10BE	(613E)
	Black Suede Powder Coat	BSP	BSP	—
	White Suede Powder Coat	WSP	WSP	—
	Wrought Black Powder Coat	WB	WB	—

## Special Finishes Description

**32DMS** (MicroShield®): As part of its promise to provide innovative solutions to their customers, ASSA ABLOY Group companies offer the MicroShield® technology, a silver-based antimicrobial coating designed to inhibit the spread of germs and bacteria.

**32316** and **32D316** are made from alloy 316 stainless steel containing molybdenum and extra nickel giving it substantially higher corrosion resistance than the standard stainless steels typically used in door hardware. This finish is ideal for use in coastal, urban, and industrial areas that have harsh environmental conditions. **32316** (polish) finishes offer the best corrosion resistance and should be used in caustic environments.

**10BE** Dark Oxidized Satin Bronze equivalent: This finish provides the richness and warmth of the 10B/613 "living" finish, but maintains its original color and appearance and will not fade or wear over time. The 10BE finish is offered by Corbin Russwin, McKinney, Norton, Rixson, Rockwood, SARGENT and Yale, providing visual consistency between ASSA ABLOY Group brands.

\* On most bronze finishes we will supply solid bronze material. Where solid bronze material is not available, we will use brass as a base material with a bronze look powder coat in its place.

\*\*\* Available on select items as indicated by the finish icon throughout the catalog.

## Wood Finishes

Wood Species and Finishes are found on page 39.



MicroShield® is a registered trademark of Yale Security Inc., an ASSA ABLOY Group company.

# ASSA ABLOY

Experience a safer  
and more open world

## Mounting Types

PULL STYLE	PULL ON ONE SIDE OF DOOR						PULL ON BOTH SIDES OF DOOR (BTB)			
	Thru Bolt	Deco Thru Bolt		Concealed			Conehead/Set Screw		Spanner Collar	
DOOR TYPE	Wood/Metal		Glass	Metal	Metal	Wood	Wood/Metal	Glass	Wood/Metal	Glass
CONEHEADS	NA	NA	NA	Single	Single	Single	Single	Single	NA	NA
MOUNTING TYPE	Type 1	Type 12	Type 15	Type 6	Type 6R	Type 8	Type 5	Type 13	Type 11	Type 14
Standard (STD) Bolt Size	1/4"-20	1/4"-20	1/4"-20	1/4"-20	1/4"-20	1/4"-20	1/4"-20	1/4"-20		
Price	INCL	28.59	33.78	8.49	13.39	11.12	8.49	15.65		
Heavy Duty (HD) Bolt Size	5/16"-18	5/16"-18	5/16"-18	5/16"-18	5/16"-18	5/16"-18	5/16"-18	5/16"-18		
Price	8.49	33.78	40.03	12.65	18.95	15.55	12.65	19.81		
Extra Heavy Duty (XHD) Bolt Size	3/8"-16	3/8"-16	3/8"-16						3/8"-16	3/8"-16
Price	12.42	36.90	43.15						32.23	38.46

Straight Pulls											
Pull Type	Dia.	MAXIMUM BOLT SIZE ALLOWED						MAXIMUM BOLT SIZE ALLOWED			
		Type 1	Type 12	Type 15	Type 6	Type 6R	Type 8	Type 5	Type 13	Type 11	Type 14
Straight	5/8"	8-32	STD	STD	8-32	8-32	8-32		STD	STD	STD
Straight	3/4"	HD	HD	HD	STD		STD	STD	STD		
Straight	1"	HD	HD	HD	HD	HD	HD	HD	HD	HD	HD
Straight	1 1/4"	HD	HD	HD	HD	HD	HD	HD	HD	HD	HD
Straight	1 1/2"	HD	HD	HD	HD	HD	HD	HD	HD	HD	HD

Offset Pulls - Postmount											
Pull Type	Dia.	MAXIMUM BOLT SIZE ALLOWED						MAXIMUM BOLT SIZE ALLOWED			
		Type 1	Type 12	Type 15	Type 6	Type 6R	Type 8	Type 5	Type 13	Type 11	Type 14
Offset	5/8"	8-32	8-32	8-32	8-32	8-32	8-32	8-32	8-32		
Offset	1"	HD	HD	HD	HD	HD	HD	HD	HD		
Offset	1 1/4"	HD	HD	HD	HD	HD	HD	HD	HD		
Offset	1 1/2"	HD	HD	HD	HD	HD	HD	HD	HD		

Offset Pulls - Tubular Bent Ends											
Pull Type	Dia.	MAXIMUM BOLT SIZE ALLOWED						MAXIMUM BOLT SIZE ALLOWED			
		Type 1	Type 12	Type 15	Type 6	Type 6R	Type 8	Type 5	Type 13	Type 11	Type 14
Offset	1"	XHD	XHD	XHD	HD	HD	HD			XHD	XHD
Offset	1 1/4"	XHD	XHD	XHD	HD	HD	HD			XHD	XHD
Offset	1 1/2"	XHD	XHD	XHD	HD	HD	HD			XHD	XHD

For all bent 1 1/4" - 1 1/2" solid Aluminums pulls and bars us the following mountings: (1HD - 12HD - 6HD - 8HD - 5HD - 15HD - 13HD)

Door Pull Mounting Details

Free End Thru Bolt

**TYPE 1 - Thru Bolt Wood or Metal Door**

Type	Bolt Size	Drill Size	Price
1	1/4"-20	9/32	Incl.
1HD	5/16"-18	11/32	8.49
1XHD	3/8"-16	13/32	12.42

**TYPE 12 - Decorative Thru Bolt Wood or Metal Door**

Type	Bolt Size	Drill Size	Price
12	1/4"-20	9/32	28.59
12HD	5/16"-18	11/32	33.78
12XHD	3/8"-16	13/32	36.90

**TYPE 15 - Decorative Thru Bolt Glass Door**

Type	Bolt Size	Drill Size	Price
15	1/4"-20	5/8	33.78
15HD	5/16"-18	5/8	40.03
15XHD	3/8"-16	5/8	43.15

Free End Concealed

**TYPE 6 - Surface Concealed Metal Door**

Minimum diameter of pull is 5/8"

Type	Bolt Size	Drill Size	Price
6	1/4"-20	1/4"-20 Tap	8.49
*6HD	5/16"-18	5/16"-18 Tap	12.65

**TYPE 6R - Surface Concealed Metal Door**

Minimum diameter of pull is 1"

Type	Bolt Size	Drill Size	Price
6	1/4"-20	N/A	13.39
*6HD	5/16"-18	N/A	18.95

**TYPE 8 - Surface Concealed Wood Door**

Type	Bolt Size	Drill Size	Price
8	1/4"-20	23/64"-9/16 dp.	11.12
*8HD	5/16"-18	7/16"-9/16 dp.	15.55

Back-to-Back

**TYPE 5 - Back-to-Back Wood or Metal Door**

Minimum diameter of pull is 5/8"

Type	Bolt Size	Drill Size	Price
5	1/4"-20	9/32	8.49
5HD	5/16"-18	11/32	12.65

**TYPE 13 - Back-to-Back Glass Door**

Type	Bolt Size	Drill Size	Price
13	1/4"-20	5/8	15.65
*13HD	5/16"-18	5/8	19.81

**TYPE 11XHD - Back-to-Back w/Spanner Collar - Wood or Metal Door**

Minimum diameter of pull is 1"

Type	Bolt Size	Drill Size	Price
11XHD	3/8"-16	13/32	32.23

**TYPE 14XHD - Back-to-Back Glass Door**

Minimum diameter of pull is 1"

Type	Bolt Size	Drill Size	Price
14XHD	3/8"-16	5/8	38.46

\*HD mountings feature 2 set screws 180° apart.

RM4800 Mounting Only

**RM4800 Series - Thru Bolt Wood or Metal Door**

Bolt Size	Drill Size	Price
3/8"-16	5/8	42.33

**RM4800 Series - Back-to-Back Wood or Metal Door**

Bolt Size	Drill Size	Price
3/8"-16	5/8	42.33

## Push and Pull Bar Mounting Details

### Sizing of Push Bars

#### Flush Doors

- Door width:
- minus 5" for bent end bars
  - minus 5" for flat end post mount bars
  - minus 7" for round end post mount bars

#### Stile and Rail Doors or Doors with Lites

- Door width:
- minus width of one stile

**CAUTION:** Always confirm bars will not interfere with jamb or cause pinching hazard.

**CAUTION:** On narrow stile doors, be sure push bar base fits on the stile and bar does not interfere with the stop.

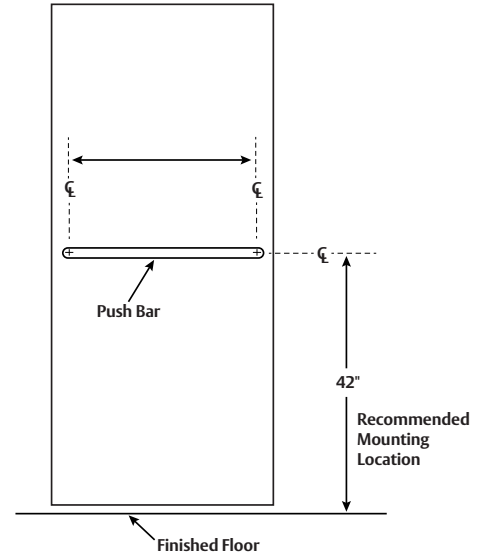

### Handing of Doors

The handing of a door is determined from the outside of the opening.

Standing outside the door:

- If the hinges are on the right, it is a right hand door.
- If the hinges are on the left, it is a left hand door.
- If the door opens away from you, it is a regular bevel door.
- If the door opens toward you, it is a reverse bevel door.

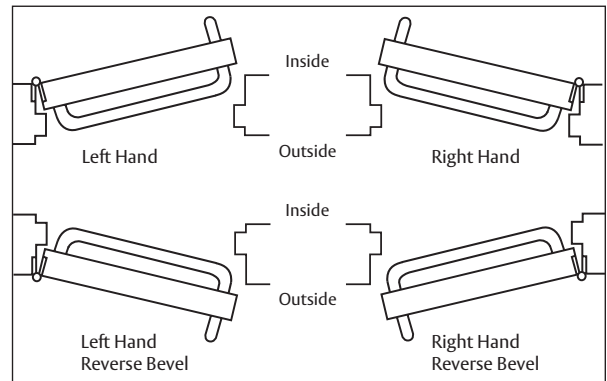

### Typical Mounting

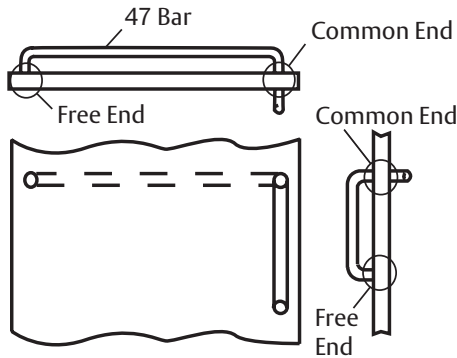

**ASSA ABLOY**

Experience a safer  
and more open world



### Thru Bolt Mounting - for 1 3/4" Wood and Metal Doors

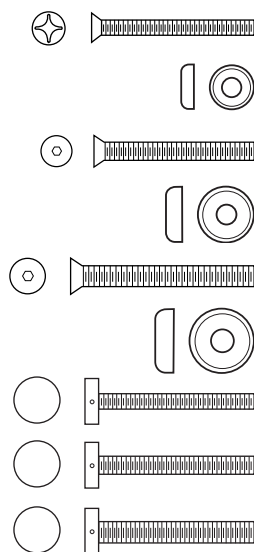

Part	Description	Mounting Type	Price
SP1004	1/4"-20 x 2 1/4" Flat Head Machine Screw Thru Bolt	1	1.26
SP1005	1/4"-20 Finishing Washer	1	0.89
SP1053	5/16"-18 x 2 1/2" Socket Flat Head Machine Screw Thru Bolt	1HD	3.43
SP1054	5/16"-18 Finishing Washer	1HD	1.27
SP1001	3/8"-16 x 2 1/2" Socket Flat Head Machine Screw Thru Bolt	1XHD	5.31
SP1002	3/8"-16 Finishing Washer	1XHD	1.59
SP1003	1" Diameter Decorative Thru Bolt 1/4"-20 x 2 1/4"	12	14.37
SP1055	1" Diameter Decorative Thru Bolt 5/16"-18 x 2 1/4"	12HD	17.12
SP1041	1 1/4" Diameter Decorative Thru Bolt 3/8"-16 x 2 1/4"	12XHD	17.12

### Back to Back Mounting - for 1 3/4" Wood and Metal Doors

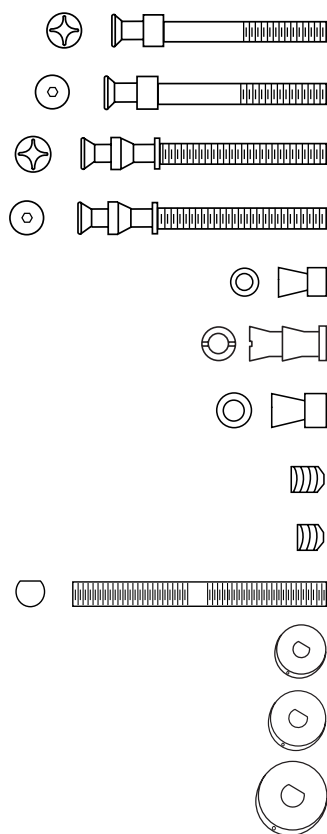

Part	Description	Mounting Type	Price
SP1025	1/4"-20 x 2 1/4" Cone Head Machine Screw	5	3.73
SP1056	5/16"-18 x 2 1/4" Cone Head Machine Screw	5HD	5.90
SP1052	1/4"-20 x 2 1/4" Double Cone Head Machine Screw (for use with offset pulls)	16	4.42
SP1057	5/16"-18 x 2 1/4" Double Cone Head Machine Screw (for use with offset pulls)	16HD	7.26
SP1027	1/4"-20 Cone Head Union (Used to Convert Cone Head to Thru Bolt Hole)	N/A	3.73
SP1079	1/4"-20 Double Cone Head Union (Used to Convert Double Cone Head to Thru Bolt Hole)	N/A	6.58
SP1068	5/16"-18 Cone Head Union (Used to Convert Cone Head to Thru Bolt Hole)	N/A	5.90
SP1026	1/4"-20 x 5/16" Set Screws (Standard)	N/A	0.89
SP1065	1/4"-20 x 3/16" Set Screw (Short)	N/A	1.16
SP1032	3/8"-16 x 3 1/2" LH/RH Bolt	11	7.79
SP1071	Spanner Collar 1" Diameter for LH/RH Bolt	11	11.78
SP1033	Spanner Collar 1 1/4" Diameter for LH/RH Bolt	11	11.78
SP1072	Spanner Collar 1 1/2" Diameter for LH/RH Bolt	11	13.11

## Concealed Mounting - for 1 3/4" Wood and Metal Doors

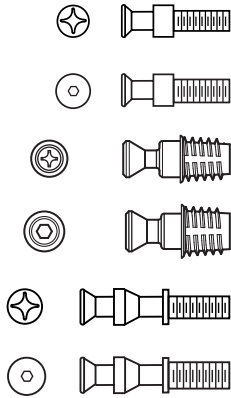

Part	Description	Mounting Type	Price
SP1039	1/4"-20 x 1/2" Cone Head Machine Screw	6 / 6R	3.73
SP1058	5/16"-18 x 1/2" Cone Head Machine Screw	6HD	5.90
SP1080	1/4"-20 Cone Head / Knife Thread Insert	8	6.21
SP1082	5/16"-18 Cone Head / Knife Thread Insert	8HD	6.21
SP1051	1/4"-20 x 1/2" Double Cone Head Machine Screw	17 / 17R	5.90
SP1059	5/16"-18 x 1/2" Double Cone Head Machine Screw	17HD	7.26

## Bushings &amp; Washers - for 1/2" Glass Doors

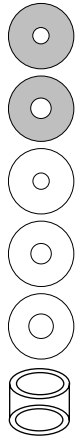

Part	Description	Mounting Type	Price
SP1022	Stainless Steel Washer for 1/4"-20 Cone Head Machine Screw .032" Thick	13	1.59
SP1060	Stainless Steel Washer for 5/16"-18 Cone Head Machine Screw .060" Thick	13HD	1.59
SP1023	Plastic Washer for 1/4"-20 Bolt; Specify Size	13	1.37
SP1061	Plastic Washer for 5/16"-18 Bolt; Specify Size	13HD	1.47
SP1062	Plastic Washer for 3/8"-16 Bolt; Specify Size	14	1.47
SP1024	Glass Door Bushing for 5/8" Hole in Glass; Specify Size	13 / 13HD / 14	1.59

## Thru Bolt Mounting - for 1/2" Glass Doors

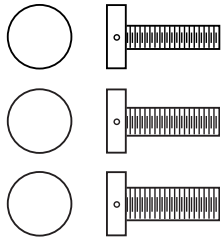

Part	Description	Mounting Type	Price
SP1020	1" Diameter Decorative Thru Bolt; 1/4"-20 x 1 1/8"	15	14.37
SP1063	1" Diameter Decorative Thru Bolt; 5/16"-18 x 1 1/8"	15HD	17.12
SP1040	1 1/4" Diameter Decorative Thru Bolt; 3/8"-16 x 1 1/8"	15XHD	17.12

**ASSA ABLOY**

 Experience a safer  
and more open world

USA &amp; Canada Prices Effective March 16, 2020

Copyright © 2020, ASSA ABLOY Accessories and Door Controls Group, Inc. All rights reserved. Reproduction in whole or in part without the express written permission of ASSA ABLOY Accessories and Door Controls Group, Inc. is prohibited.

### Back to Back Mounting - for 1/2" Glass Doors

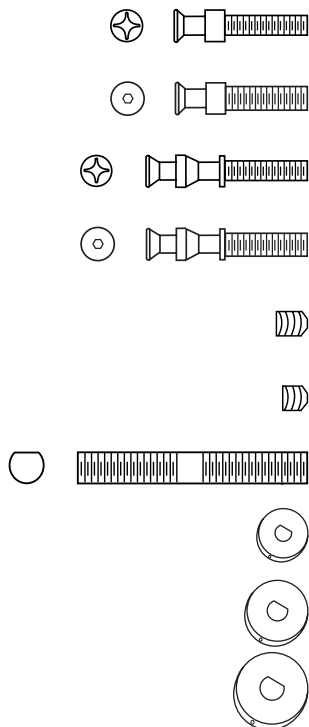

Part	Description	Mounting Type	Price
SP1021	1/4"-20 x 1 1/8" Cone Head Machine Screw	13	3.73
SP1064	5/16"-18 x 1 1/8" Cone Head Machine Screw	13HD	5.90
SP1067	1/4"-20 x 1 1/8" Double Cone Head Machine Screw	18	5.90
SP1066	5/16"-18 x 1 1/8" Double Cone Head Machine Screw	18HD	7.26
SP1026	1/4"-20 x 5/16" Set Screw (Standard)	N/A	0.89
SP1065	1/4"-20 x 3/16" Set Screw (Short)	N/A	1.16
SP1031	3/8"-16 x 1 3/4" LH/RH Bolt (If SP1031 is ordered and KIT 14 is not called out fastener will be 2 1/4")	14	7.79
SP1071	Spanner Collar 1" Diameter for LH/RH Bolt	14	11.78
SP1033	Spanner Collar 1 1/4" Diameter for LH/RH Bolt	14	11.78
SP1072	Spanner Collar 1 1/2" Diameter for LH/RH Bolt	14	13.11

### Y Base Plates

Specify bolt hole size and finish. Standard pulls require two plates.

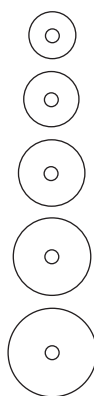

Part	Description	For Use With	Price
SP1073	1/8" Thick x 1 1/16" Diameter	3/4" Diameter Pulls	14.37
SP1074	1/8" Thick x 1 1/4" Diameter	1" Diameter Pulls and Posts	14.37
SP1075	1/8" Thick x 1 1/2" Diameter	1" Diameter Pulls and Posts	14.37
SP1076	1/8" Thick x 1 3/4" Diameter	1" Diameter Pulls and Posts	14.37
SP1077	1/8" Thick x 2" Diameter	1" Diameter Pulls and Posts	14.37

### Flush Pull Fasteners

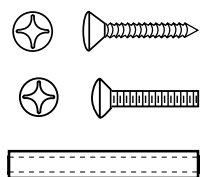

Part	Description	Door Type	Price
SP1006	#8 x 3/4" Oval Head Sheet Metal Screw	Wood or Metal	0.68
SP1007	#8-32 x 3/4" Oval Head Machine Screw	Metal	0.68
SP1034	#8-32 x 1 5/8" Brass Sleeve Machine Screw	Wood or Metal	3.96

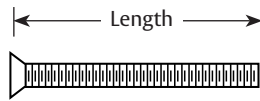
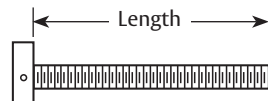
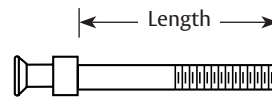
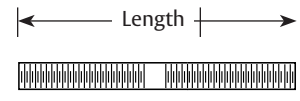
Standard Thru Bolt for  
Countersunk HolesDecorative Thru Bolt for  
Wood or Metal DoorsCone Head Bolt for Back-to-Back  
Wood or Metal Doors

LH/RH Bolt without Heads

## Mounting Kits for Door Pulls

Part	Mounting Type	Description	Price
KIT1	1	2 ea. 1/4"-20 x 2 1/4" Thru Bolts and 2 ea. Finish Washers; Specify Finish	4.25
KIT1HD	1HD	2 ea. 5/16"-18 x 2 1/2" Thru Bolts and 2 ea. Finish Washers; Specify Finish	8.49
KIT1XHD	1XHD	2 ea. 3/8"-16 x 2 1/2" Thru Bolts and 2 ea. Finish Washers; Specify Finish	12.42
KIT5	5	2 ea. 1/4"-20 x 2 1/4" Cone Head Bolts and 4 ea. Set Screws	8.49
KIT5HD	5HD	2 ea. 5/16"-18 x 2 1/4" Cone Head Bolts and 4 ea. Set Screws	12.65
KIT6	6	2 ea. 1/4"-20 x 1 1/2" Cone Head Bolts and 4 ea. Set Screws	8.49
KIT6HD	6HD	2 ea. 5/16"-18 x 1 1/2" Cone Head Bolts and 4 ea. Set Screws	12.65
KIT11	11	2 ea. 3/8"-16 x 3 1/2" LH/RH Bolt and 2 ea. Spanner Collars for 1 3/4" Doors; Specify Pull Diameter and Finish	32.23
KIT12-1	12	2 ea. 1/4"-20 x 2 1/4" Decorative Thru Bolts; 1" Dia.; Specify Finish	28.59
KIT12-1HD	12HD	2 ea. 5/16"-18 x 2 1/4" Decorative Thru Bolts; 1" Dia.; Specify Finish	33.78
KIT12-1.25XHD	12XHD	2 ea. 3/8"-16 x 2 1/4" Decorative Thru Bolts; 1 1/4" Dia.; Specify Finish	36.90
KIT13	13	2 ea. 1/4"-20 x 1 1/8" Cone Head Bolts; 2 ea. Metal Washers; 4 ea. Plastic Washers; 2 ea. Bushings for 1/2" Glass Doors; 4 ea. Set Screws; Specify if other than 1/2" Glass	15.65
KIT13HD	13HD	2 ea. 5/16"-18 x 1 1/8" Cone Head Bolts; 2 ea. Metal Washers; 4 ea. Plastic Washers; 2 ea. Bushings for 1/2" Glass Doors; 4 ea. Set Screws; Specify if other than 1/2" Glass	19.81
KIT14	14	2 ea. 3/8"-16 x 2 1/4" LH/RH Bolt; 2 ea. Spanner Collars; 2 ea. Bushings; 4 ea. Washers for 1/2" Glass Doors; Specify Pull Diameter and Finish	38.46
KIT15	15	2 ea. 1/4"-20 x 1 1/8" Decorative Thru Bolts; 1" Dia.; 2 ea. Bushings; 4 ea. Plastic Washers; Specify Finish and Glass Thickness/Hole Size	33.78
KIT15HD	15HD	2 ea. 5/16"-18 x 1 1/8" Decorative Thru Bolts; 1" Dia.; 2 ea. Bushings; 4 ea. Plastic Washers; Specify Finish and Glass Thickness/Hole Size	40.03
KIT15-1.25XHD	15XHD	2 ea. 3/8"-16 x 1 1/8" Decorative Thru Bolts; 1 1/4" Dia.; 2 ea. Bushings; 4 ea. Plastic Washers; Specify Finish and Glass Thickness/Hole Size	43.15
KIT15-1.5XHD	15XHD	2 ea. 3/8"-16 x 1 1/8" Decorative Thru Bolts; 1 1/2" Dia.; 2 ea. Bushings; 4 ea. Plastic Washers; Specify Finish and Glass Thickness/Hole Size	49.37
KIT16	16	2 ea. 1/4"-20 x 2 1/4" Double Cone Head Bolts and 4 ea. Set Screws	12.65
KIT16HD	16HD	2 ea. 5/16"-18 x 2 1/4" Double Cone Head Bolts and 4 ea. Set Screws	15.65

Part	Mounting Type	Description	Price
KIT17	17	2 ea. 1/4"-20 x 1 1/2" Double Cone Head Bolts and 4 ea. Set Screws	12.65
KIT17HD	17HD	2 ea. 5/16"-18 x 1 1/2" Double Cone Head Bolts and 4 ea. Set Screws	15.65
KIT18	18	2 ea. 1/4"-20 x 1 1/8" Double Cone Head Bolts; 2 ea. Metal Washers; 4 ea. Plastic Washers; 2 ea. Bushings for 1/2" Glass Doors; Specify if other than 1/2" Glass and 4 ea. Set Screws	21.67
KIT18HD	18HD	2 ea. 5/16"-18 x 1 1/8" Double Cone Head Bolts; 2 ea. Metal Washers; 4 ea. Plastic Washers; 2 ea. Bushings for 1/2" Glass Doors; Specify if other than 1/2" Glass and 4 ea. Set Screws	24.78
KIT-T1	T1	1 ea. 1/4"-20 X 2 1/4" Cone Head Bolt; 1 ea. 1/4"-20 Cone Head Union; 2 ea. Set Screws; 2 ea. 1/4"-20 x 2 1/4" — 1" Dia. Decorative Thru Bolts; Specify Finish	36.89
KIT-T2	T2	1 ea. 1/4"-20 X 1 1/8" Cone Head Bolt; 1 ea. 1/4"-20 Cone Head Union; 2 ea. Set Screws; 2 ea. 1/4"-20 x 1 1/8" — 1" Dia. Decorative Thru Bolts; 1 ea. Metal Washer; 6 ea. Plastic Washers; 3 ea. Bushings; Specify Finish	46.26
KIT-T3	T3	1 ea. 1/4"-20 X 2 1/4" Cone Head Bolt; 1 ea. 1/4"-20 Cone Head Union; 2 ea. Set Screws; 2 ea. 1/4"-20 x 2 1/4" Thru Bolts; 2 ea. Finish Washers; Specify Finish	12.63
KIT-T4	T4	1 ea. 1/4"-20 X 2 1/4" Cone Head Bolt; 2 ea. 1/4"-20 x 1 1/2" Cone Head Bolts; 3 ea. Set Screws	12.63
KIT-T5	T5	1 ea. 1/4"-20 X 2 1/4" Cone Head Bolt; 2 ea. 1/4"-20 x 1 1/2" Cone Head Wood Screws; 3 ea. Set Screws	12.63
KITRM1.25	11x1XHD	2 ea. 3/8"-16 x 2 1/2" Thru-Bolts; 2 ea. Finish Washers; 1 ea. 3/8"-16 x 3 1/2" LH/RH Bolt; 1 ea. 1 1/4" Spanner Collar; Specify Finish	28.59
KITRM360	11x 12XHD	2 ea. 3/8"-16 x 2 1/4" Decorative Thru Bolts 1 1/4" Dia.; 1 ea. 3/8"-16 x 3 1/2" LH/RH Bolt; 1 ea. 1 1/4" Spanner Collar; Specify Finish	53.01
KITRM360G	14x 15XHD	2 ea. 3/8"-16 x 2 1/4" Decorative Thru Bolts 1 1/4" Dia.; 1 ea. 3/8"-16 x 2 1/4" LH/RH Bolt; 1 ea. 1 1/4" Spanner Collar; 3 ea. Bushings; 6 ea. Plastic Washers; Specify Finish	62.38
KITRM1.5	11x1XHD	2 ea. 3/8"-16 x 2 1/2" Thru Bolts; 2 ea. Finish Washers; 1 ea. 3/8"-16 x 3 1/2" LH/RH Bolt; 1 ea. 1 1/2" Spanner Collar; Specify Finish	31.70
KITRM380	11x 12XHD	2 ea. 3/8"-16 x 2 1/4" Decorative Thru Bolts 1 1/2" Dia.; 1 ea. 3/8"-16 x 3 1/2" LH/RH Bolt; 1 ea. 1 1/2" Spanner Collar; Specify Finish	62.38
KITRM380G	14x 15XHD	2 ea. 3/8"-16 x 2 1/4" Decorative Thru Bolts 1 1/2" Dia.; 1 ea. 3/8"-16 x 1 1/4" LH/RH Bolt; 1 ea. 1 1/2" Spanner Collar; 3 ea. Bushings; 6 ea. Plastic Washers; Specify Finish	71.73

# ASSA ABLOY

Experience a safer  
and more open world

USA & Canada Prices Effective March 16, 2020

Copyright © 2020, ASSA ABLOY Accessories and Door Controls Group, Inc. All rights reserved. Reproduction in whole or in part without the express written permission of ASSA ABLOY Accessories and Door Controls Group, Inc. is prohibited.

## Discontinued Products

Coat Hooks
RM809
RM810
RM824
RM825
RM826
RM827

RM3100 MegaTek Series - See RM3300 MegaTek Series on pg. 18 for equivalent pulls.	
Discontinued Part #	Equivalent Part #
RM3100	RM3300
RM3110	RM3301
RM3120	RM3302
RM3130	RM3310
RM3140	RM3311
RM3150	RM3312
RM3104	RM3320
RM3114	RM3321
RM3124	RM3322
RM3134	RM3330
RM3144	RM3331
RM3154	RM3332

RM3200 NeoTek Series - See RM3400 NeoMax Series on pg. 21 for equivalent pulls.	
Discontinued Part #	Equivalent Part #
RM3200	RM3400
RM3210	RM3401
RM3220	RM3402
RM3230	RM3410
RM3240	RM3411
RM3250	RM3412
RM3204	RM3420
RM3214	RM3421
RM3224	RM3422
RM3234	RM3430
RM3244	RM3431
RM3254	RM3432

Partial RM3500 LineaMet Series - See LineaMax Series on pg. 23 for equivalent pulls	
Discontinued Part #	Equivalent Part #
RM3510	RM3701
RM3520	RM3702
RM3540	RM3711
RM3550	RM3712
RM3514	RM3751
RM3524	RM3752
RM3544	RM3761
RM3554	RM3762

Partial RM3600 LineaTek Series - See LineaMax Series on pg. 24 for equivalent pulls	
Discontinued Part #	Equivalent Part #
RM3610	RM3721
RM3620	RM3722
RM3640	RM3731
RM3650	RM3732
RM3614	RM3771
RM3624	RM3772
RM3644	RM3781
RM3654	RM3782

Centek - Radius Pulls
RM4300
RM4301
RM4302
RM4303
RM4304
RM4305

## Discontinued Products (con't)

**CenTrex - Large Radius Pulls**

RM4550

RM4552

**SculpTrex - Shaped Cast Pulls**

RM5000

RM5002

RM5010

RM5012

RM5020LH

RM5020RH

RM5030

RM5032

RM5040

RM5042

RM5050LH

RM5050RH

**Classic - Finial Door Pulls**

RM5600

RM5602

RM5604

RM5610

RM5612

RM5614

**Partial RM6000 English Bridle Leather Series -  
See English Bridle Leather series on pg. 42 for  
equivalent pulls**

Discontinued Part #	Equivalent Part #
RM6000	RM6060
RM6010	RM6061
RM6020	RM6062
RM6030	RM6070
RM6040	RM6071
RM6050	RM6072
RM6004	RM6080
RM6014	RM6081
RM6024	RM6082
RM6034	RM6090
RM6044	RM6091
RM6054	RM6092

**Partial RM6100 Upholstery Leather Series -  
See Upholstery Leather series on pg. 44 for  
equivalent pulls**

Discontinued Part #	Equivalent Part #
RM6100	RM6160
RM6110	RM6161
RM6120	RM6162
RM6130	RM6170
RM6140	RM6171
RM6150	RM6172
RM6104	RM6180
RM6114	RM6181
RM6124	RM6182
RM6134	RM6190
RM6144	RM6191
RM6154	RM6192

**ASSA ABLOY**Experience a safer  
and more open world

## Notes

---

The ASSA ABLOY Group is the global leader in access solutions. Every day we help people feel safe, secure and experience a more open world.

**ASSA ABLOY**



ASSA ABLOY Opening Solutions  
Architectural Accessories Group  
Rockwood, PA  
P: 800-458-2424 • F: 800-922-9212  
[www.assaabloydooraccessories.us](http://www.assaabloydooraccessories.us)

(In Canada)  
Door Security Solutions Canada  
160 Four Valley Drive  
Vaughan, ON L4K 4T9  
P: 800-461-3007  
[www.assaabloydss.ca](http://www.assaabloydss.ca)