

SARGENT®

ASSA ABLOY

6 Line Parts List



For assistance, contact SARGENT at
800-727-5477 or www.sargentlock.com

WARNING

This product can expose you to lead which is known to the state of California to cause cancer and birth defects or other reproductive harm. For more information go to www.P65warnings.ca.gov.

08/2018

6 Line Knob/Lever Lock

PARTS LIST
PAGE NO. REV. C
6.0 8/1/03

Table of Contents

Page

Lock Functions	6.1
Lock Illustration	6.2
Parts List	6.3

6 Line Knob/Lever Lock Functions

SHADED KNOB MEANS RIGID AT ALL TIMES
 HALF SHADED KNOB MEANS RIGID WHEN LOCKED
 SPECIFIED SIDE MAY BE FURNISHED WITH SL LEVER HANDLE

PARTS LIST

PAGE NO. REV. C
 6.1 8/1/03

6G04
 STOREROOM, CLOSET

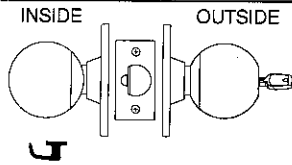

6G24
 ENTRY, OFFICE

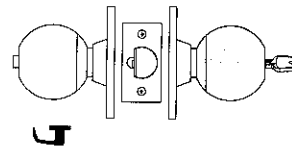

6U65
 PRIVACY, BATHROOM

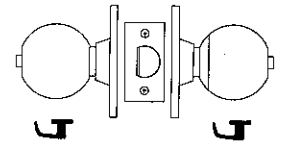

6G05
 ENTRANCE, OFFICE

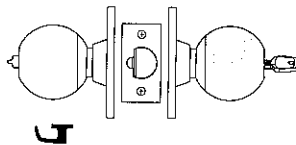

6G37
 CLASSROOM

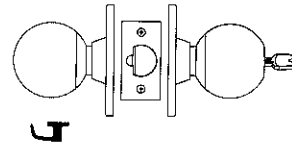

6G75-2
 TWIN COMMUNICATING

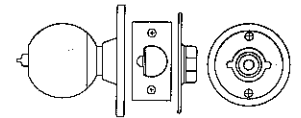

6U15
 PASSAGE

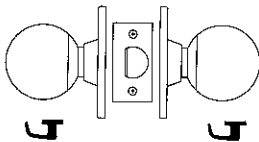

6G38-2
 TWIN COMMUNICATING
 EXIT

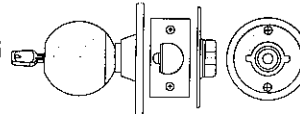

6U93
 SINGLE KNOB PULL

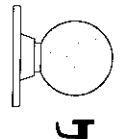

6G15-3
 TWIN COMMUNICATING

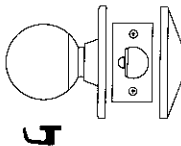

6G50
 HOTEL

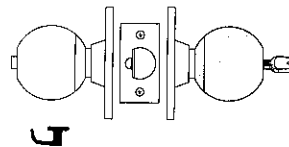

6U94
 DOUBLE KNOB PULL

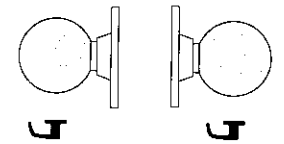

6 Line Knob/Lever Lock

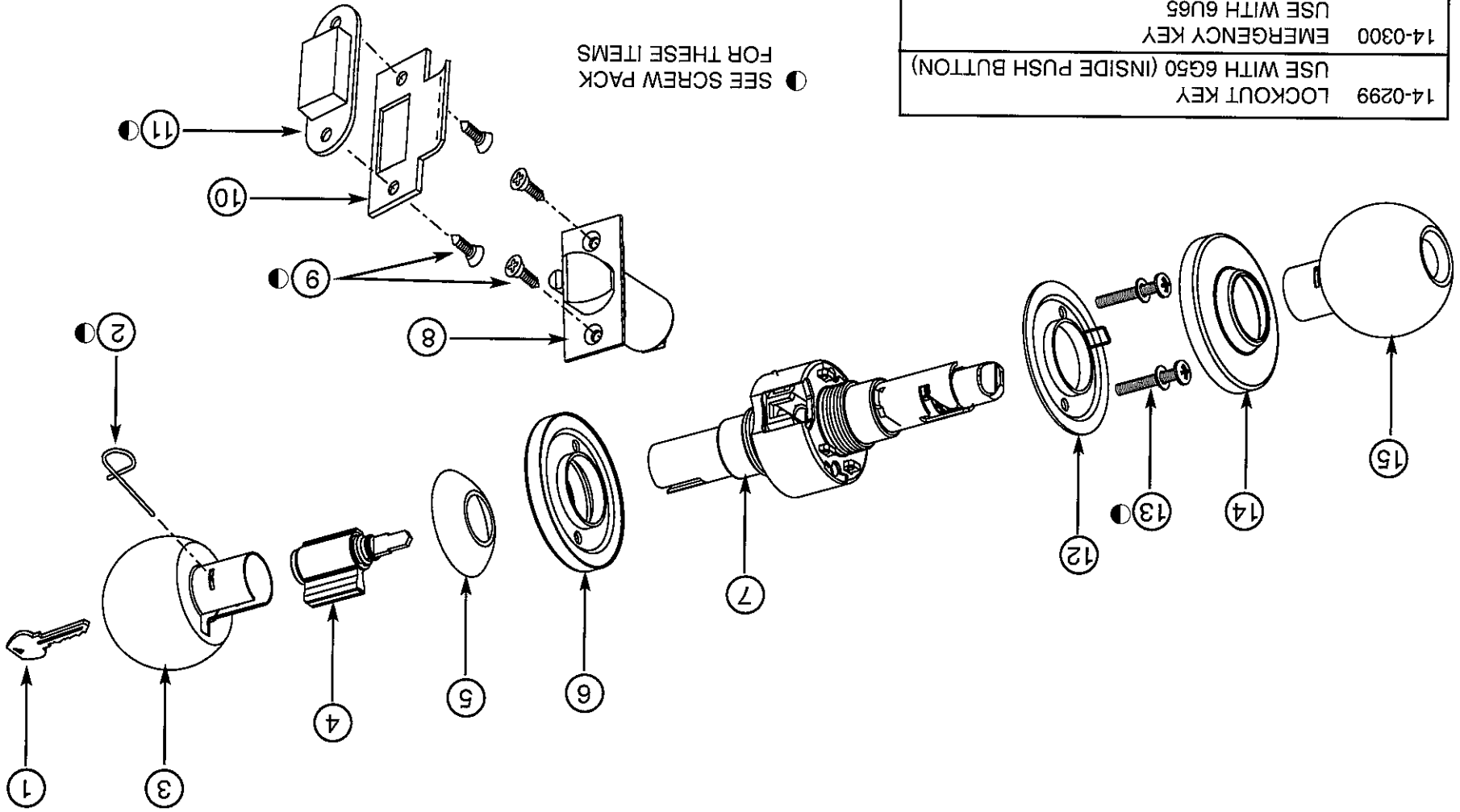

● SEE SCREW PACK FOR THESE ITEMS

6G05 FUNCTION SHOWN

14-0299	LOCKOUT KEY	USE WITH 6G50 (INSIDE PUSH BUTTON)
14-0300	EMERGENCY KEY	USE WITH 6U65

6 Line Knob/Lever Lock Parts List**Page No. 6.3**
Rev. D 6/01/12

Item	Part No.	Description
1	Key	Varies
2	Push Pin	See Screw Packs
3	Outside Knob	06-0500 06-0501 06-0502 06-0503 06-0603 (LH) 06-0604 (RH) 06-0504 06-0505
	Outside Lever	06-5181 06-5182
4	Cylinder	Varies
5	Knob Ferrule	06-0512
		06-0528
6	Outside Rose Assembly	06-5005
		06-5006
7	Lockbodies B Knob	06-5039
		06-5040
		06-5011
		06-5017
		06-5041
		06-5240
		06-5241
		06-5043
		06-5044
		06-5045
	Lockbodies S Knob/SL Lever	06-5016
		06-5012
06-5011		
06-5017		
Lockbodies Removeable Core (S Knob)	06-5149 (LH) 06-5150 (RH)	
	06-5151 (LH) 065152- (RH)	
	06-5153 (LH) 06-5154 (RH)	
	06-5217 (LH) 06-5218 (RH)	
	06-5188 (LH) 06-5189 (RH)	
	06-5013	

6 Line Knob/Lever Lock Parts List**Page No. 6.3**
Rev. D 6/01/12

Item	Part No.	Description
8	Latchbolts	06-5083 Guarded 06-5225 Unguarded 06-5085 Guarded 06-5227 Unguarded 06-5094 Guarded 06-5231 Unguarded 06-5102 Guarded 06-5234 Unguarded 06-5096 Guarded 06-5232 Unguarded 06-5100 Guarded Drive-in Latchbolt
9	Flat Head Screws	See Screw Packs
10	Strikes	600 Kit 506 Kit 808 Kit
11	Strike Box	Standard Strike Full Lip Strike 4-7/8" Strike
12	Mounting Plate	Provided with Screw Pack 77-1141
13	Mounting Screws	Standard Strike Box 4-7/8" Strike Box
14	Inside Rose	06-5003 B&O Rose
15	Inside Knob	See Screw Pack
	Inside Lever	06-0532 06-0533 B Design O Design
		06-0500 06-0501 06-0502 06-0503 06-0603 (LH) 06-0604 (RH) 06-0504 06-0505 B Design cylinder - Standard B Design Push Button B Design Plain/Passage S Design Cylinder - Standard S Design Cylinder - Removable Core S Design Push Button S Design Plain/Passage
		06-5182 06-5181 SL Design Push Button SL Design Plain/Passage

Screw Packs		
Standard Finish Screws	06-2675	4 qty. #6-20 x 3/4" Flat head screws & Strike Box
Mounting/Thru-bolt Screws	06-5056	2 qty. #10-32 x 1-3/8" Machine screws
6U93 6U94 (Requires 2 screw packs) Metal Door	06-5058	2 qty. #8-32 x 3/4" Sheet metal screws
6U93 6U94 (Requires 2 screw packs) Wood Door	06-5059	2 qty. #6-20 x 3/4" Wood screws